

IMPERX



Cheetah Pregius Cameras User Manual with CoaXPress Interface

The Imperx Cheetah CMOS cameras provide exceptional video image quality in a remarkably compact and ruggedized design with resolutions of 17, 20 and 31 MP. The cameras use Sony 3rd generation Pregius CMOS sensors for their high sensitivity, image clarity, and high dynamic range. They achieve frame rates up to 56.5 frames per second with dual CXP-6 CoaXPress output interface and support power over CoaXPress (PoCXP).

Revision 1.2

About Imperx, Inc.

IMPERX, Inc. is a leading designer and manufacturer of high performance, high quality digital cameras, frame grabbers, and accessories for industrial, commercial, military, and aerospace imaging applications including flat panel inspection, biometrics, aerial mapping, surveillance, traffic management, semiconductors and electronics, scientific & medical Imaging, printing, homeland security, space exploration, and other imaging and machine vision applications.

Fortune 100 companies, federal and state government agencies, domestic and foreign defense agencies, academic institutions, and other customers worldwide use IMPERX products.

Imperx, Inc. | 6421 Congress Ave. | Boca Raton, FL, 33487

US Phone: +1 (561) 989-0006

Warranty

IMPERX warrants performance of its products and related software to the specifications applicable at the time of sale in accordance with IMPERX's standard warranty, which is 2 (two) years parts and labor.

Do not open the housing of the camera. Warranty voids if the housing has been open or tampered.

IMPORTANT NOTICE

This camera has been tested and complies with the limits of Class A digital device, pursuant to part 15 of the FCC rules.

Copyright © 2020, 2021 IMPERX Inc. All rights reserved. All information provided in this manual is believed to be accurate and reliable. No responsibility is assumed by IMPERX for its use. IMPERX reserves the right to make changes to this information without notice. Redistribution of this manual in whole or in part, by any means, is prohibited without obtaining prior permission from IMPERX. IMPERX reserves the right to make changes to its products or to discontinue any product or service without notice and advises its customers to obtain the latest version of relevant information to verify, before placing orders, that the information being relied on is current.

IMPERX PRODUCTS ARE NOT DESIGNED, INTENDED, AUTHORIZED, OR WARRANTED TO BE SUITABLE FOR USE IN LIFE-SUPPORT APPLICATIONS, DEVICES OR SYSTEMS OR OTHER CRITICAL APPLICATIONS, WHERE MALFUNCTION OF THESE PRODUCTS CAN REASONABLY BE EXPECTED TO RESULT IN PERSONAL INJURY. IMPERX CUSTOMERS USING OR SELLING THESE PRODUCTS FOR USE IN SUCH APPLICATIONS DO SO AT THEIR OWN RISK AND AGREE TO FULLY INDEMNIFY IMPERX FOR ANY DAMAGES RESULTING FROM SUCH IMPROPER USE OR SALE.



TABLE OF CONTENTS

About the Camera	10
General	10
Key Features	11
Technical Specifications	12
CXP-C5440 Camera Specifications	12
CXP-C4440 Camera Specifications	13
CXP-C6440 Camera Specifications	14
Ordering Information	15
Accessories	15
Technical Support	16
Hardware	17
CXP-C4440, CXP-C5440, and CXP-C6440 Cameras Connectivity	17
Pin Assignments	19
Camera LED Status Indicator	20
Powering the Camera	20
PS12V14A Power Supply	21
PS12V14A Power Supply Specifications	22
Connecting the PS12V14A Power Supply	23
I/O Cable CBL-PWIO01	24
Active Canon EF mount	25
Electrical Connectivity	26
Opto-Isolated Input	26
TTL/LVTTL Input	26
TTL Output	26
Opto-Isolated Output	27
Mechanical Drawings	29
CXP-C4440, CXP-C5440, and CXP-C6440 Cameras	29
Mounting Plate	31
Optical	32
Environmental	33
Handling the Camera	34
GenICam™ API Module – Configuring the Camera	35
Overview	35
Camera Startup	35
GenApi Camera Configuration	35
Device Control Category	36
Version Information Category	39
Image Format Control Category	42
Acquisition Control Category	47
Analog Control Category	50
Data Correction Category	52
Auto White Balance, Exposure and Gain Algorithm Control Category	54
Digital Input / Output Control Category	58
Pulse Generator Category	61
Canon Lens Control Category	62
Transport Layer Control Category	66
User Set Control Category	68

Special Features Category.....	69
Camera Features	70
Image Data Flow	70
Exposure Control	71
Exposure Control in Free-Running Mode.....	71
Exposure Control in Trigger Mode.....	73
Global Shutter.....	75
Automatic Exposure and Gain Control	76
P, I, and D Coefficients.....	78
Proportional Response.....	79
Integral Response	79
Derivative response	79
Camera Triggering	80
Standard Trigger Mode.....	81
Fast Trigger Mode.....	83
Trigger Sources	84
Configuring the Trigger	85
Video Amplifier Gain and Offset.....	87
Image Sensor’s Analog and Digital Gain	87
Digital Gain.....	87
Black Level Auto-Calibration and Offset	87
Data Output Format	88
Pulse Generator.....	89
Input / Output Control.....	90
Strobe and Synchronization Controls	91
Configuring the Strobe in Free-Running Mode.....	92
Configuring a Strobe in Trigger Mode.....	94
Area of Interest.....	99
Horizontal and Vertical Window.....	99
Factors Impacting Frame Rate	99
Binning and Sub-Sampling Decimation.....	100
Binning.....	100
Sub-Sampling Decimation	101
Transfer Function Correction.....	102
Gamma Control.....	102
Factory LUTs.....	103
User Defined LUT	103
Hot and Defective Pixel Correction	104
Flat Field Correction	104
Test Image Pattern	105
Automatic White Balance.....	106
Configuration Memory	109
CXP Link Customization	110
Canon Lens Control.....	112
Focus Control.....	112
Iris Control	113
Image Sensor Technology	114
General Information	114
Spectral Sensitivity.....	115

Appendix A: Spectral Response.....	116
Cheetah C4440 Spectral Response	116
Cheetah C5440 Spectral Response	117
Cheetah C6440 Spectral Response	118
Appendix B: Creating Hot and Defective Pixel Correction Maps.....	119
Overview	119
Editing HPM / DPM Files	119
Finding Defective Pixels	120
Finding Hot Pixels.....	120
Locating and adding pixel coordinates	122
Creating a DPM/HPM Using a Text Editor	125
Creating a DPM Using Imperx Toolkit.....	126
Creating an HPM Using Imperx Toolkit.....	127
Uploading DPM / HPM Files	128
Appendix C: Look Up Tables.....	130
Creating an LUT Using a Text Editor	130
Creating an LUT Using Microsoft Excel.....	131
Creating an LUT Using Imperx Toolkit	132
Uploading the LUT File.....	136

REVISION HISTORY

Revision	Date	Reviser	Comments
1.0	05/15/2020	I. Barabanova	Initial release.
1.1	01/19/2021	I. Barabanova	<p>Changed Canon Lens Control specifications. Added Focus and Iris adjustment procedures for a Canon Lens. Added the <i>DeviceTemperatureSelector</i> parameter. Updated mechanical drawings. Updated Appendix B and C. Added UKCA compliance. Added new Power Supply PS12V14A. Added MTBF for CXP-C6440 and CXP-C5440</p>
1.2	8/24/2021	I. Barabanova	<p>Adjusted the internal camera temperature to 80 °C (the camera's fan turns on automatically if the internal camera temperature exceeds 80 °C) Updated strobe diagrams.</p>

ADDITIONAL RESOURCES

Name of the document	Description	Where to find
ANP11 Cheetah Pregius CXP Custom Links Application Note	This application note describes how to change CXP link configuration on the Imperx Cheetah Pregius CoaXPress camera.	Cheetah CXP ZIP folder
Imperx Sensor Cleaning Procedure	The Sensor Cleaning Procedure provides instructions on cleaning an image sensor.	

TERMINOLOGY

Defective pixels – these are pixels whose sensitivity deviates due to fluctuations in the CMOS manufacturing process and materials.

Fast trigger mode – a camera exposes a frame and then exposes the next frame while reading out the previous frame. In this way, the camera overlaps the exposure and readout times. Fast trigger mode requires a predictable and stable trigger period. The *TriggerOverlap* setting is On.

Free-running mode – a camera runs without synchronization to an external trigger pulse (untriggered mode).

Hot pixels – these are pixels that in normal camera operation behave as normal pixels (sensitivity equal to one of the adjacent pixels). But during long exposures or at elevated temperatures, the pixel becomes far brighter than the average of the pixels surrounding it. In some cases, the pixel becomes so bright that it saturates.

Standard trigger mode – a camera waits for a trigger pulse, then exposes using an internal exposure timer and reads out a frame and waits for next trigger pulse. The exposure and readout do not overlap. The *TriggerOverlap* setting is Off.

Trigger mode – a camera waits for a trigger pulse to start the image capture, synchronizing it to either an internal or external event.

AEC – Automatic exposure control

AGC – Automatic gain control

AOI – Area of interest

AWB – Automatic white balance

CXP – CoaXPress

FFC – Flat field correction

LUT – Look-up table

PoCXP – Power over CoaXPress

TEC – Thermoelectric cooling

About the Camera

General

The Imperx Cheetah CoaXPress cameras feature 2-channel CXP-6 CoaXPress interface and comply with CoaXPress Standard v1.1 transferring data with 6.25 Gbps per one channel (up to 12.5 Gbps via two channels).

The CoaXPress Cheetah CMOS cameras are built around advanced Sony Pregius CMOS image sensors with global shutter for high quality images in a small ruggedized form factor. Cheetah cameras are progressive scan digital cameras featuring a built-in image-processing engine, low power consumption, low noise, high dynamic range (71 dB), and fast frame rates for high throughput applications.

The cameras provide several trigger modes and output strobes allowing you to synchronize the image capture of one or more cameras to an external event. You can vary exposure times using internal controls or an external pulse width.

The cameras also provide an area of interest (AOI), programmable look-up tables (LUT) and the ability to store up to four different camera configurations. Using the simple GenICam™ compliant user interface, you can quickly change the camera configuration. Built-in gamma correction and user-defined LUT capabilities optimize the cameras' dynamic range. Hot and defective pixel correction is available to correct over-responding or under-responding pixels.

The cameras are suitable for a wide range of environmental conditions and applications, such as machine vision, industrial inspection, surveillance, aerospace, and more.

The C5440, C4440, and C6440 cameras feature 17 MP, 20 MP, and 31 MP Sony Pregius CMOS sensors respectively, provide support for active Canon EOS lens with iris and focus controls, and are available with thermoelectric cooling. The thermoelectric cooling stabilizes the sensor temperature to reduce thermal noise and allow for predictable dark current correction.

Camera Model	Resolution (MP)	Resolution (H x V)	Frame Rate (Max)	Type (Color/ Mono)	Optical format	Pixel Size (microns)	Sony Sensor Model
CXP-C5440	17	5472 x 3084	56.5	C, M	4/3"	3.45	IMX387
CXP-C4440	20	4416 x 4436	39.6	C, M	4/3"	3.45	IMX367
CXP-C6440	31	6464 x 4860	35.4	C, M	APS-C	3.45	IMX342

Key Features

- Global shutter (GS)
- Color and monochrome versions
- Fast frame rates
- High data transfer rates up to 6.25 Gbps per one cable
- Uses micro-BNC (HD-BNC) connectors
- Internal and external exposure controls
- Automatic exposure and gain control (AEC/AGC)
- Analog and digital gain control
- Offset control
- Built-in pulse generator
- Area of interest (AOI)
- Programmable external inputs and outputs
- Multiple Trigger/Synchronization options
- Automatic white balance
- Gamma correction
- Four 12-bit look-up tables (LUT)
- Hot and defective pixel correction, user-defined and factory
- Eight flat field correction tables, user defined and factory
- Dynamic transfer function and gamma corrections
- Canon EOS EF lens control (optional)
- Forced air cooling (optional Thermal Electric Cooler (TEC))
- Power over CoaXPress or alternative power from external power supply
- Temperature monitor
- Field upgradeable firmware

Technical Specifications

CXP-C5440 Camera Specifications

Specifications	CXP-C5440 (17 MP)
Active image resolution	5472 (H) x 3084 (V)
Pixel size	3.45 μm
Optical format	4/3 inch
Shutter	Global
Frame rate (max)	56.5 fps (8-bit), 55.3 fps (10-bit), 40.4 fps (12-bit)
Sensor digitization	10 or 12-bit
Dynamic range	71 dB
Output bit depth	8, 10, or 12-bit
Shutter speed	36 μs to 16.0 s
Analog / Digital gain	Manual, auto, once; 0–48 dB (0.1 dB step)
Digital gain	1x (0 dB) to 4x (12 dB), 0.001x step
AEC/AGC	Off, once, auto
Gamma correction	0.00 to 4.00 with a step of 0.01
Black level offset	Manual (0–4095), auto
Exposure control	Manual, auto, once, external, off
White balance	Manual, auto, once, off
Area of Interest (AOI)	One
Binning	1x2, 2x1, 2x2 (available only for monochrome sensors)
Sub-sampling decimation	1x2, 2x1, 2x2
Trigger inputs	External, pulse generator, software, link trigger (trigger over CXP)
Trigger options	Edge, pulse width, trigger filter, trigger delay, debounce
Trigger modes	Free-run, standard, fast
I/O control	2 IN (OPTO, LVTTTL) / 2 OUT (OPTO, TTL)
Strobe output	2 strobes, programmable position and duration
Pulse generator	Yes, programmable
Data correction	2 LUTs pre-programmed with Gamma 0.45, 2 LUTs pre-programmed with Negative LUT; Hot and Defective pixel correction (static); 8 Flat field correction tables
Lens mount	F-mount (default), Canon EOS active or passive, M42 (optional)
Camera housing	6000 series aluminum
Upgradeable firmware	Yes
Forced Air Cooling Control	On, off, auto
Supply voltage range	Power over CoaXPress or 12 V/24 V external power supply (optional)
Power consumption	Typ. (Fan is on/auto): 9.2 W (at 25 °C); Max. (Fan is off): 9.9 W (at 25 °C)
Camera size (W x H x L)	60 mm x 60 mm x 60.2 mm
Weight	500 g
Vibration, shock	20G (20–200 Hz XYZ) / 100G
Environmental	Operating -30 °C to +65 °C (Fan is on/auto); -30 °C to +50 °C (Fan is off) Storage -40 °C to +85 °C
Relative humidity	10% to 90% non-condensing
MTBF (using Telcordia RS-332)	451,875 hours @ 50 °C (Fan is off)
Regulatory	FCC part 15 Class A, CE, RoHS, UKCA

CXP-C4440 Camera Specifications

Specifications	CXP-C4440 (20 MP)
Active image resolution	4416 (H) x 4436 (V)
Pixel size	3.45 μm
Optical format	4/3 inch
Shutter	Global
Frame rate (max)	39.6 fps (8-bit), 39.6 fps (10-bit), 28.3 fps (12-bit)
Sensor digitization	10 or 12-bit
Dynamic range	71 dB
Output bit depth	8, 10, or 12-bit
Shutter speed	36 μs to 16.0 s
Analog / Digital gain	Manual, auto, once; 0–48 dB (0.1 dB step)
Digital gain	1x (0 dB) to 4x (12 dB), 0.001x step
AEC/AGC	Off, once, auto
Gamma correction	0.00 to 4.00 with a step of 0.01
Black level offset	Manual (0–4095), auto
Exposure control	Manual, auto, once, external, off
White balance	Manual, auto, once, off
Area of Interest (AOI)	One
Binning	1x2, 2x1, 2x2 (available only for monochrome sensors)
Sub-sampling decimation	1x2, 2x1, 2x2
Trigger inputs	External, pulse generator, software, link trigger (trigger over CXP)
Trigger options	Edge, pulse width, trigger filter, trigger delay, debounce
Trigger modes	Free-run, standard, fast
I/O control	2 IN (OPTO, LVTTTL) / 2 OUT (OPTO, TTL)
Strobe output	2 strobes, programmable position and duration
Pulse generator	Yes, programmable
Data correction	2 LUTs pre-programmed with Gamma 0.45, 2 LUTs pre-programmed with Negative LUT; Hot and Defective pixel correction (static); 8 Flat field correction tables
Lens mount	F-mount (default), Canon EOS active or passive, M42 (optional)
Camera housing	6000 series aluminum
Upgradeable firmware	Yes
Forced Air Cooling Control	On, off, auto
Supply voltage range	Power over CoaXPress or 12 V/24 V external power supply (optional)
Power consumption	Typ. (Fan is on/auto): 9.2 W (at 25 °C); Max. (Fan is off): 9.9 W (at 25 °C)
Camera size (W x H x L)	60 mm x 60 mm x 60.2 mm
Weight	500 g
Vibration, shock	20G (20–200 Hz XYZ) / 100G
Environmental	Operating -30 °C to +65 °C (Fan is on/auto); -30 °C to +50 °C (Fan is off) Storage -40 °C to +85 °C
Relative humidity	10% to 90% non-condensing
Regulatory	FCC part 15 Class A, CE, RoHS, UKCA

CXP-C6440 Camera Specifications

Specifications	CXP-C6440 (31 MP)
Active image resolution	6464 (H) x 4860 (V)
Pixel size	3.45 μm
Optical format	APS-C
Shutter	Global
Frame rate (max)	35.4 fps (8-bit), 35.0 fps (10-bit), 25.1 fps (12-bit)
Sensor digitization	10 or 12-bit
Dynamic range	71 dB
Output bit depth	8, 10, or 12-bit
Shutter speed	36 μs to 16.0 s
Analog / Digital gain	Manual, auto, once; 0–48 dB (0.1 dB step)
Digital gain	1x (0 dB) to 4x (12 dB), 0.001x step
AEC/AGC	Off, once, auto
Gamma correction	0.00 to 4.00 with a step of 0.01
Black level offset	Manual (0–4095), auto
Exposure control	Manual, auto, once, external, off
White balance	Manual, auto, once, off
Area of Interest (AOI)	One
Binning	1x2, 2x1, 2x2 (available only for monochrome sensors)
Sub-sampling decimation	1x2, 2x1, 2x2
Trigger Inputs	External, pulse generator, software, link trigger (trigger over CXP)
Trigger options	Edge, pulse width, trigger filter, trigger delay, debounce
Trigger modes	Free-run, standard, fast
I/O control	2 IN (OPTO, LVTTTL) / 2 OUT (OPTO, TTL)
Strobe output	2 strobes, programmable position and duration
Pulse generator	Yes, programmable
Data correction	2 LUTs pre-programmed with Gamma 0.45, 2 LUTs pre-programmed with Negative LUT; Hot and Defective pixel correction (static); 8 Flat field correction tables
Lens mount	F-mount (default), Active or passive Canon EOS, M42 (optional)
Camera housing	6000 series aluminum
Upgradeable firmware	Yes
Forced Air Cooling Control	On, off, auto
Supply voltage range	Power over CoaXPress or 12 V/24 V external power supply (optional)
Power consumption	Typ. (Fan is on/auto): 9.2 W (at 25 °C); Max. (Fan is off): 9.9 W (at 25 °C)
Camera size (W x H x L)	60 mm x 60 mm x 60.2 mm
Weight	500 g
Vibration, shock	20G (20–200 Hz XYZ) / 100G
Environmental	Operating -30 °C to +65 °C (Fan is on/auto); -30 °C to +50 °C (Fan is off) Storage -40 °C to +85 °C
Relative humidity	10% to 90% non-condensing
MTBF (using Telcordia RS-332)	451,875 hours @ 50 °C (Fan is off)
Regulatory	FCC part 15 Class A, CE, RoHS, UKCA

Ordering Information

When ordering a camera, please specify the camera ordering code. To create your own customer Cheetah ordering code, simply choose one element from each column:

Interface	Camera model	Sensor Type	Ruggedized	Lens Mount	Filter/customization options
CXP = 2-channel CXP-6 CoaXPress w/PoCXP	C5440 – 5472 x 3084 C4440 – 4416 x 4436 C6440 – 6464 x 4860	C = Color M = Monochrome	R = Ruggedized	F = F-Mount M = M42 L = Canon EF EOS Active Mount E = Canon EF EOS Passive Mount	000 = none

- 000 (none)** filter/customization option means that a color camera has an IR-cut filter, while a monochrome camera does not have any filters.
- Sample codes:
CXP-C5440C-RL000: Cheetah Color 17 MP camera with Canon EF EOS active mount and 2-channel CXP-6 CoaXPress w/PoCXP interface.
CXP-C6440M-RF000: Cheetah Monochrome 31 MP camera with F-Mount and 2-channel CXP-6 CoaXPress w/PoCXP interface.
- The Imperx PS12V14A power supply is available for use with CXP cameras and can be purchased separately.

Accessories

Imperx offers a power supply, cable, and fan assembly for use with the cameras. The accessories are sold separately.

Part Number	Description	Compatible with:
PS12V14A	Standard Power Supply 12 V DC, 3 A, With one strobe and one trigger, 1.75 m length	CXP-C4440, CXP-C5440, CXP-C6440
CBL-PWIO01	Power and Input/Output Cable, 12-pin (F) Hirose to loose end, 2 m	
ASSY-5100-0027	Fan assembly and four M2.0x0.4 screws	

NOTE  The Cheetah CXP camera ships with the fan assembly installed. If necessary, you can order the replacement fan assembly ASSY-5100-0027.

Technical Support

Each camera is fully tested before shipping. If, for some reason, the camera is not operational after power up, check the following:

1. Check the CoaXPress and all I/O cables.
Make sure that all the connectors are firmly attached.
2. Check the status LED and verify that it is steady ON, if not – refer to the section [Camera LED Status Indicator](#).
3. Enable the test mode and verify that the communication between a computer and the camera is established.
If the test pattern is not present, power off the camera, check all the cabling, frame grabber settings, and computer status.

If you still have problems with the camera operation, contact technical support at:

Email: support@imperx.com

Toll Free 1 (866) 849-1662 or (+1) 561-989-0006

Fax: (+1) 561-989-0045

Visit our website: www.imperx.com

Hardware

This chapter contains the detailed information needed for the initial design-in process:

- connector types, pin numbering and assignments
- electrical connectivity and voltage requirements
- mechanical drawings and cabling
- optical and environmental information

CXP-C4440, CXP-C5440, and CXP-C6440 Cameras Connectivity

The back panel of the camera provides all the connectors needed to operate and control the camera and an LED status indicator.

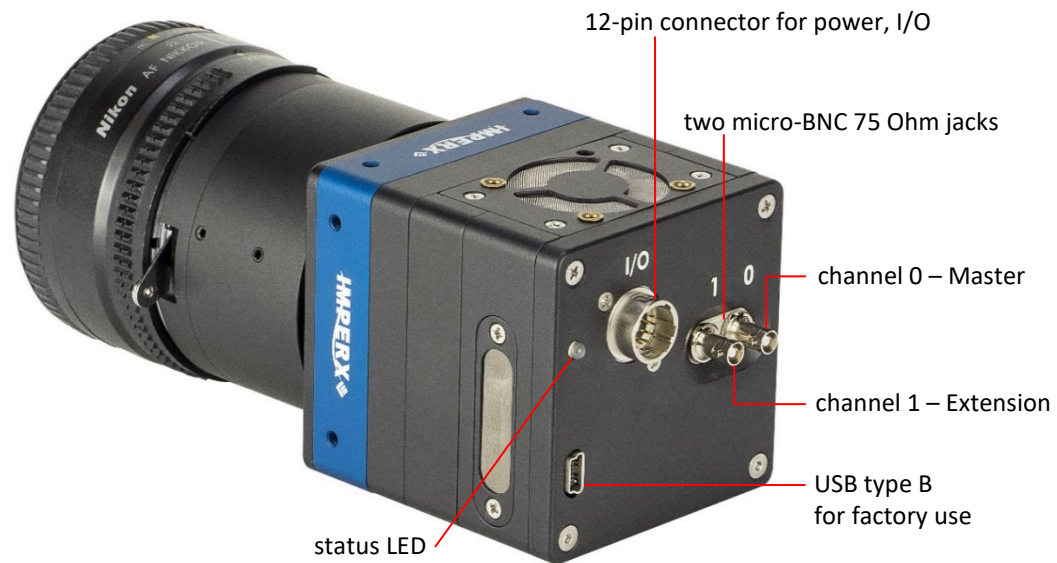

The camera provides the following connectors:

- two micro-BNC (HD-BNC) 75 Ohm jacks providing 2-channel data output, control data (including Canon lens control), trigger, and power over CoaXPress
- male 12-pin Hirose miniature locking receptacle #HR10A-10R-12PB(71) providing alternative power input and I/O interface. Use a female Hirose miniature locking plug #HR10A-10P-12S(73) on the mating end of your I/O cable
- a camera status LED indicator
- USB type B programming/SPI connector
- the camera's model and serial number

The camera's video data output, control data, and triggers are serialized and continuously transmitted over CoaXPress (CXP-6) using a standard 75-ohm mini-coaxial cable.

The interface provides a high-speed downlink up to 6.25 Gbps for video transport, lower speed 20 Mbps uplink for communication and control, and power (up to 13 W via one CXP cable).

The coaxial cable connected to the Channel 0 (Master) provides power over CoaXPress (PoCXP).

NOTE  The CXP output interface requires a CoaXPress frame grabber for collecting and storing the camera's output, providing power and, if required, a trigger pulse over CoaXPress. The frame grabber installs in the host computer and enables you to view images and configure the camera.

The frame grabber, connectors, and coaxial cables **MUST** comply with the CoaXPress v1.1 standard.

Use a CoaXPress cable with micro-BNC (HD-BNC) connectors.

TIP  When connecting the camera to a frame grabber, attach Channel 0 (Master) to the frame grabber's master channel (refer to the documentation on your frame grabber).

The new Cheetah CXP camera comes from the Factory configured for operation with two CXP cables. If operation with a single CXP cable is desired, the camera must first be connected to the CXP frame grabber with two cables and then the Link Configuration changed as described in [CXP Link Customization](#) section.

If using only one CXP channel, always connect a coaxial cable to Channel 0 (Master).

Pin Assignments



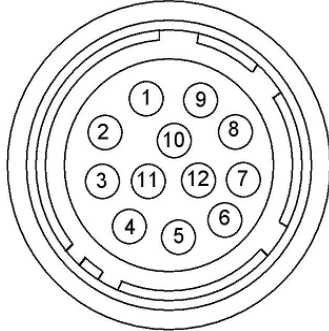

The 12-pin Hirose connector on the camera's back panel is a male type miniature locking receptacle #HR10A-10R-12PB(71).



Pin	Signal Name	Use
1	12/24 VDC Return	12 or 24 VDC Main Power Return
2	+12/24 VDC	12 or 24 VDC Main Power
3	Reserved	Reserved
4	Reserved	Reserved
5	OUT2 RTN	General Purpose Output 2, Contact 1 (Opto-isolated)
6	OUT1 RTN	General Purpose Output 1 Return (TTL)
7	OUT1	General Purpose Output 1 (TTL)
8	INPUT1	General Purpose Input 1 (Opto-isolated)
9	INPUT2	General Purpose Input 2 (TTL/LVTTL)
10	INPUT1 RTN	General Purpose Input 1 Return (Opto-isolated)
11	INPUT2 RTN	General Purpose Input 2 Return (TTL/LVTTL)
12	OUT2	General Purpose Output 2, Contact 2 (Opto-isolated)

Camera LED Status Indicator

The camera has a red-green-yellow LED on the back panel of the camera. The following LED colors and light patterns indicate the camera status and mode of operation:

LED Color	Light Patterns	Status Description
	Green steady ON	Camera connected, but no data being transferred
	Fast flashing green	Camera connected; data being transferred
	Green/Amber fast flashing alternation	Connection detection in progress, PoCXP active (Shown for a minimum of 1 s even if the connection detection is faster)
	LED Off	No power

Powering the Camera



The maximum supply voltage **must not** exceed 33 V DC.

The camera can be powered either through the CoaXPress port (Power over CoaXPress (PoCXP)) or through the Hirose connector (pins 1 and 2) using an external power supply.

The external power supply should provide 6.5 V – 33 V DC with the inrush current 2 A @ 12 V. The power supply should terminate in a female HIROSE plug #HR10A-10P-12S(73).

Imperx offers the PS12V14A Power Supply adapter for use with the cameras. The PS12V14A power supply can be purchased separately. It ships with a power cable that terminates in a female HIROSE plug #HR10A-10P-12S(73). The PS12V14A includes connectors for trigger (black wire) and strobe (white wire). Refer to the section [PS12V14A Power Supply](#) for more information.

When the camera is powered over CoaXPress, you can use cable assembly CBL-PWIO01 for transmitting external trigger and strobe signals (see [I/O Cable CBL-PWIO01](#)).

PS12V14A Power Supply

The PS12V14A power supply provides +12 V DC \pm 5% and up to 3 A DC current. The operating input voltage range is from 100 to 240 V AC.

PS12V14A Power Supply Components

The PS12V14A power supply is comprised of three components:

Item	Qty.
PS12V10 Universal power supply	1
CBL-PWR-0014 power cable	1
power cord	1

The CBL-PWR-0014 cable terminates in a female Hirose type miniature locking plug #HR10A-10P-12S(73). It has two BNC pig-tail cables providing external trigger input (black) and strobe output (white).

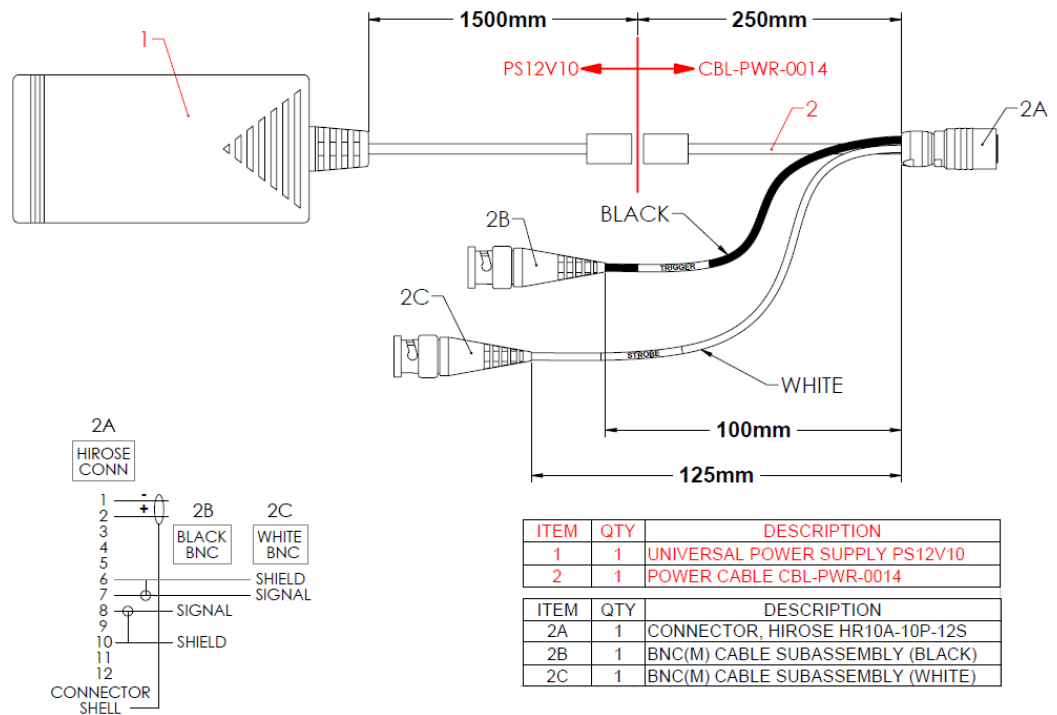

Imperx recommends using the PS12V14A power supply for powering CXP-C4440, CXP-C5440, and CXP-C6440 cameras.

PS12V14A Power Supply Specifications

Specifications		Description
Input		
Voltage		100–240 V AC
Frequency		50–60 Hz
Current		1 A max
Inrush Current		70 A max / 230 V AC (cold start @ 25 °C, full load)
Efficiency		Eff (av) ≥ 87.4 % (at 115 V AC & 230 V AC) Eff ≥ 78.303 % (at 230V/50Hz input @10% load for CoC Tier2)
Output		
Voltage		11.4 V to 12.6 V DC, 12 V DC nominal
Current		3 A max
Load Regulation		± 5%
Ripple & Noise		1% Vpp max for Output Voltage @ full load
Total Power		36 W Max
Protection		
Over-Voltage Protective (OVP)		V out * 180% (max)
Short-Circuit Protective (SCP)		Automatic recovery after short circuit fault being removed
Over Current Protection (OCP)		I out * 200% (max)
Safety, EMI and EMC Requirement		
Safety		UL, CUL, GS, PSE, BSMI, CB, RCM, CCC, KC, LPS
Dielectric Strength		10 mA max. cut off current
		(1) Primary to Secondary: 3000 V AC for 1 minute
		(2) Primary to Frame Ground: 1500 V AC for 1 minute
Insulation Resistance		(1) Primary to Secondary: 10 MOhm for 500 V DC
		(2) Primary to Frame Ground: 10 MOhm for 500 V DC
EMI Requirement		CE, FCC Class B, Conduction and Radiation meet
Leakage Current		Less than 3.5 mA
Grounding Test		Resistance 0.1 Ohm max @ 32 A
Environmental	Operating	0 °C to +40 °C
	Storage	-20 °C to +80 °C
Relative humidity	Operating	20% to 80% non-condensing
	Storage	10% to 90% non-condensing
Regulatory		DoE VI, ErP (Lot 7), GEMS, NRCAN, CEC, RoHS
Cable Length		
Supplied AC power input cable (IEC)		1.8 m (6')
Power supply output (+12 V)		1.75 m (5') ± 15 cm (6"), connector HIROSE #HR10A-10P-12S
Strobe		12.5 cm (5") ± 1 cm (0.4") connector BNC male
Trigger		10 cm (4") ± 1 cm (0.4") connector BNC male

Connecting the PS12V14A Power Supply

1. Connect a power cord to the PS12V10 power adapter.
2. Connect the KPPX-4P plug of the PS12V10 power adapter to the KPJX-CM-4S socket of the CBL-PWR-0014 cable.

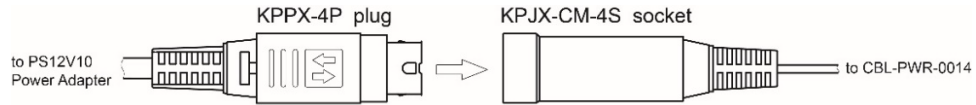

CAUTION

Push connectors together until the locking mechanism clicks, and there is no gap between the connectors. If connectors are not securely locked, overheating may occur resulting in damage to the cable or leading to fire.

Correct position

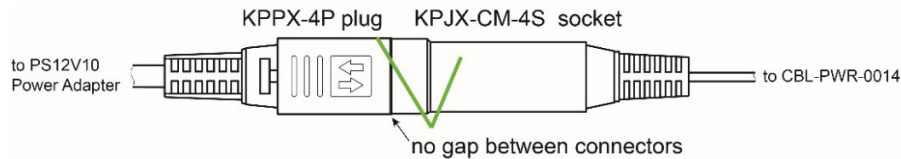

Incorrect position

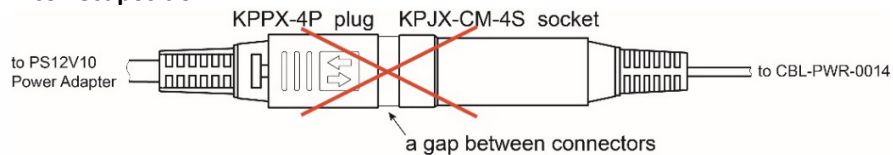

3. Connect the other end of the CBL-PWR-0014 cable to the Cheetah CXP camera.
4. If applicable, connect Trigger and/or Strobe cables to external devices.

CAUTION

To disconnect the CBL-PWR-0014 cable from the PS12V10 power adapter, pull on the plug KPPX-4P. Do not pull on the cable. Doing so may result in damage to the cable.

PS12V14A Connection Diagram

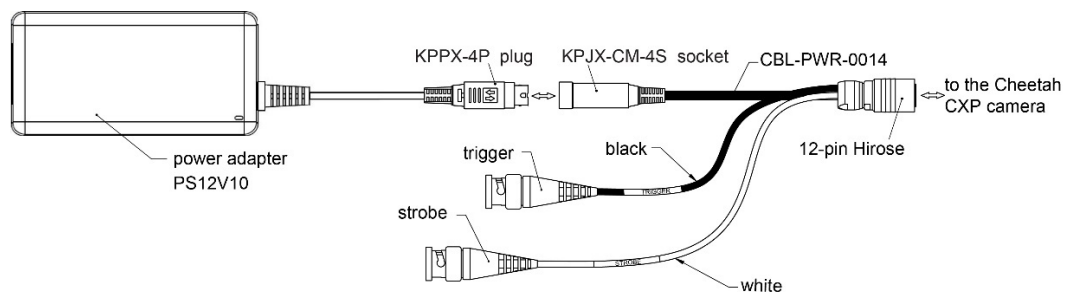

I/O Cable CBL-PWIO01

The optionally purchased CBL-PWIO01 cable assembly is used with CXP-C4440, CXP-C5440, and CXP-C6440 cameras for transmitting external trigger and strobe signals when the cameras are powered using CoaXPress cable. It terminates in a 12-pin female HIROSE plug #HR10A-10P-12S(73) on the one end and 12 loose wires on the opposing.

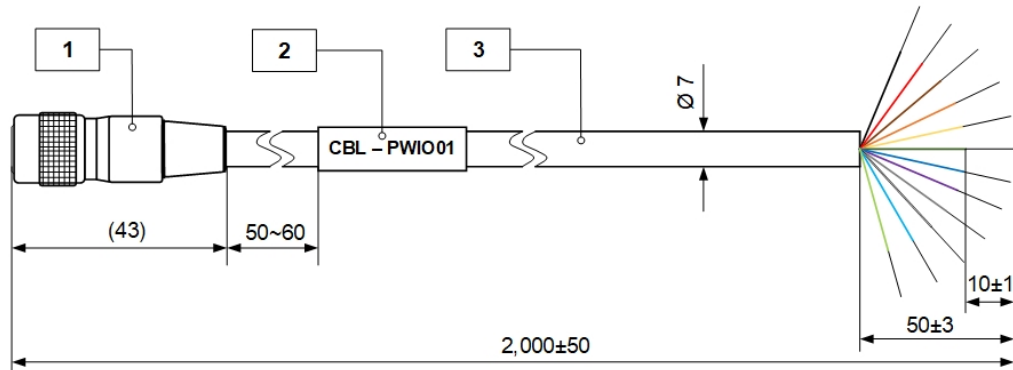

Hirose
HR10A-10P-12S(73)
Rear view

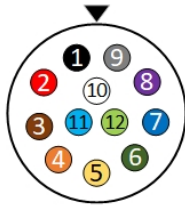

Pin	Wire color	Signal
1	Black	12/24 V DC RTN
2	Red	+12/24 V DC
3	Brown	Reserved
4	Orange	Reserved
5	Yellow	OUT2 RTN (OPTO)
6	Green	OUT1 RTN (TTL)
7	Blue	OUT1 (TTL)
8	Violet	IN1 (OPTO)
9	Gray	IN2 (TTL/LVTTL)
10	White	IN1 RTN (OPTO)
11	Sky Blue	IN2 RTN (TTL)
12	Yellowish Green	OUT2 (OPTO)

} alternative power
(connect if applicable)

Unit	Item	QTY	Description
mm	1	1	Hirose HR10A-10P-12S(73)
	2	1	Shrinking label Ø 8 mm x 30 mm
	3	1	Cable Ø 7 mm, 2 meters

Active Canon EF mount

The Canon EF lens mount provides active lens control for C4440, C5440, and C6440 cameras.

The cameras provide communication and power to the mount through an internal connector on the front of the camera. The connector eliminates the need for a special power supply and external cable between the camera and the Canon EF mount.

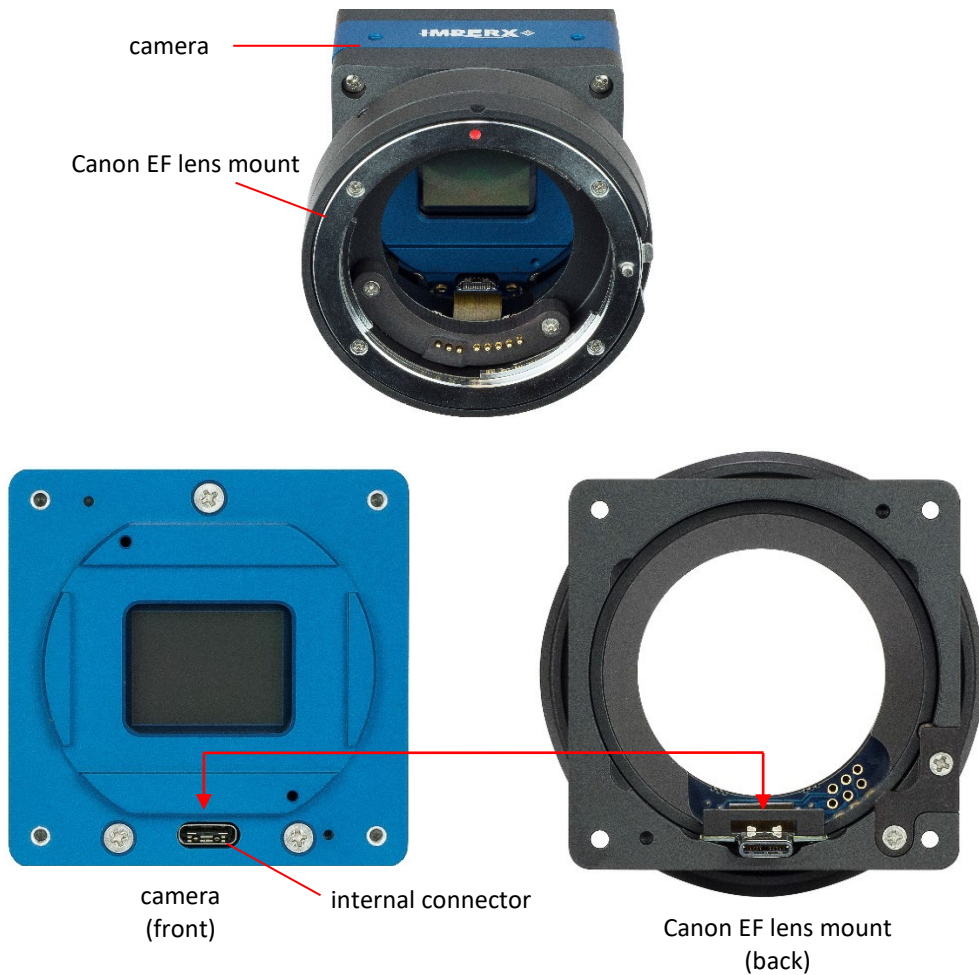

Electrical Connectivity

The Cheetah camera has two external inputs, INPUT1 and INPUT2. INPUT1 is optically isolated while INPUT2 accepts low voltage TTL (LVTTTL). The camera provides two general-purpose outputs. Output OUT1 is a 5 V TTL compatible signal and output OUT2 is opto-isolated. The following figures show the external input and output electrical connections.

Opto-Isolated Input

Input signals INPUT1 and INPUT1 RTN are optically isolated. The voltage difference between the two must be positive between 3.3 V and 24 V. The minimum input current is 3.3 mA.

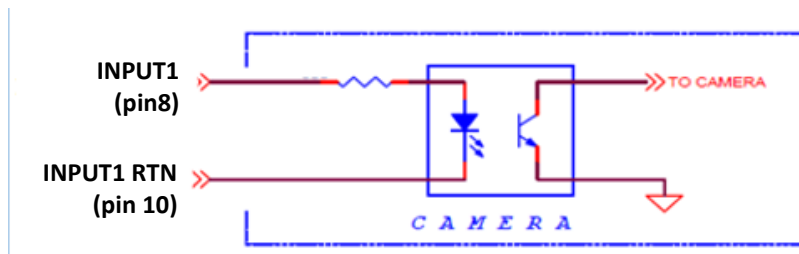

TTL/LVTTL Input

Input signals INPUT2 and INPUT2 RTN provide interfaces to a TTL or LVTTTL input signal. The signal level (voltage difference between the inputs INPUT2 and INPUT2 RTN) **must be** LVTTTL (3.3 V) or TTL (5.0 V). The total maximum input current **must not** exceed 2.0 mA.

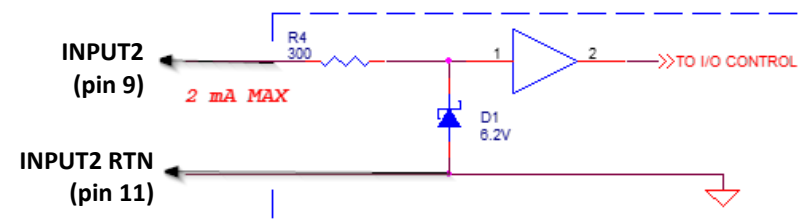

TTL Output

TTL output provides interface to a TTL compatible output signal. The signal level (voltage difference between the outputs OUT1 and OUT1 RTN) is TTL (5.0 V). The maximum output current **must not** exceed 8.0 mA.

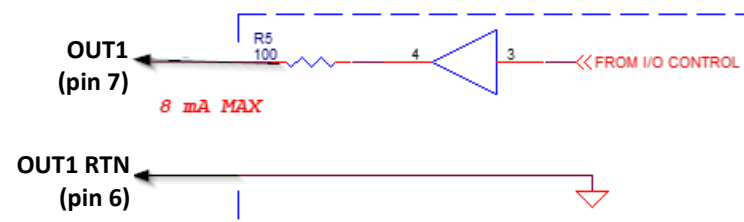

Opto-Isolated Output

Opto-isolated output is an optically isolated switch. There is no pull-up voltage on either contact. An external pull-up voltage of up to 25 V is required for operation. Output is not polarity sensitive. AC or DC loads are possible. The voltage across Contact 1 and Contact 2 **must not** exceed 25 V and the current through the switch **must not** exceed 50 mA. 'On' resistance is less than 5 Ohms.

OUT2 Open drain logic driver circuit:

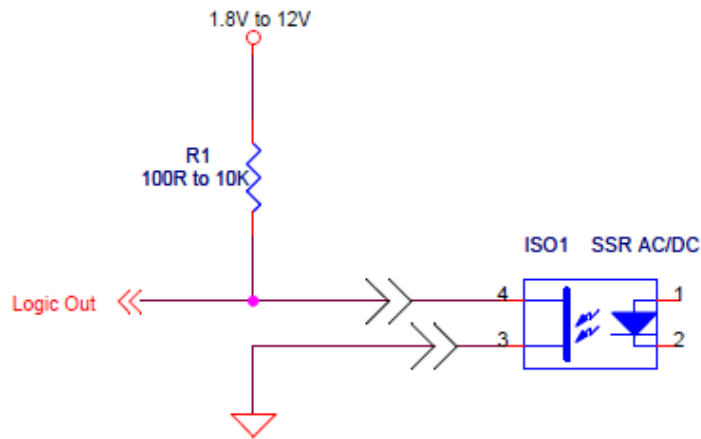

OUT2 Low side load driver circuit:

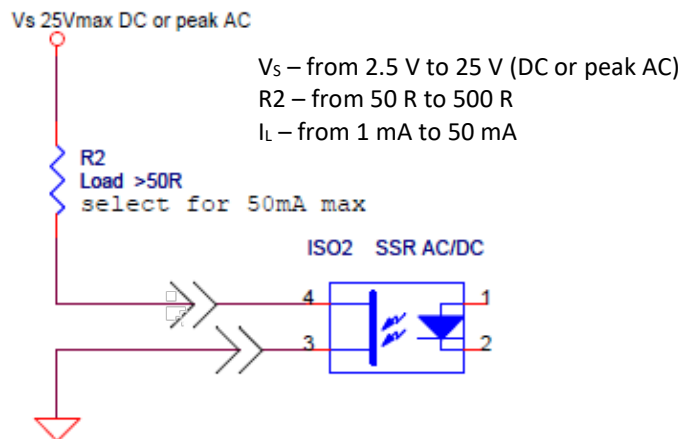

OUT2 High side load driver circuit:

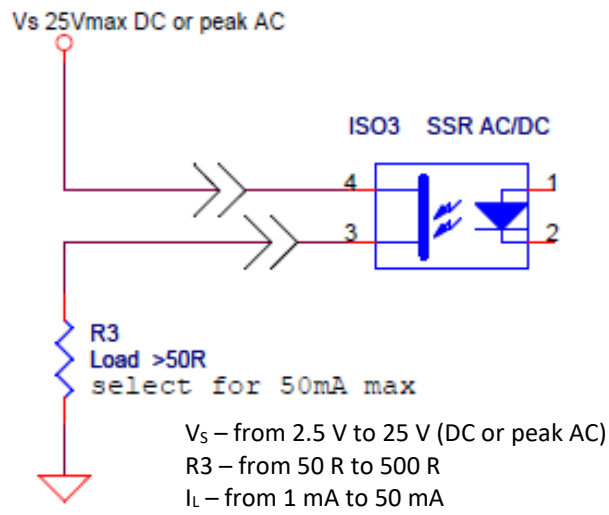

Mechanical Drawings

CXP-C4440, CXP-C5440, and CXP-C6440 Cameras

The camera housing is made of precision-machined aluminum. For maximum flexibility, the camera has eight M3X0.5mm mounting holes located towards the front of the camera on all four sides. An additional plate with ¼-20 UNC (tripod mount) and hardware ship with each camera.

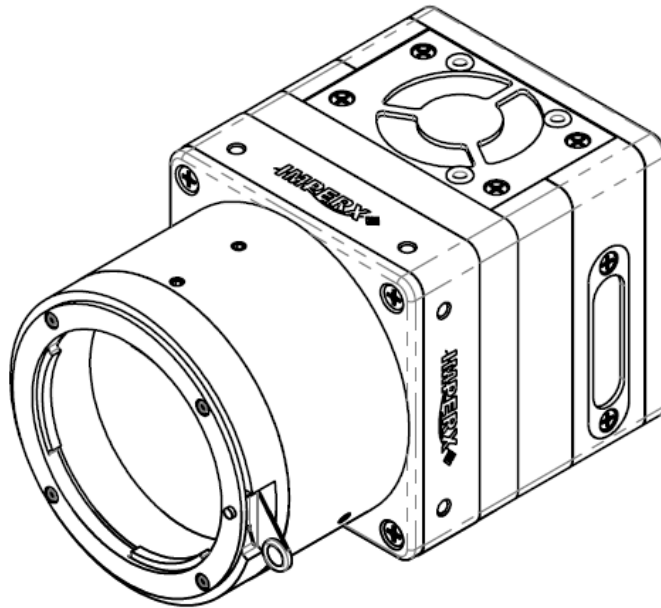

Front View:

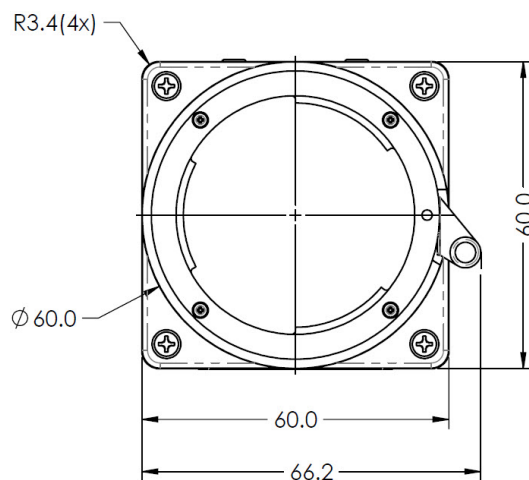

Back View:

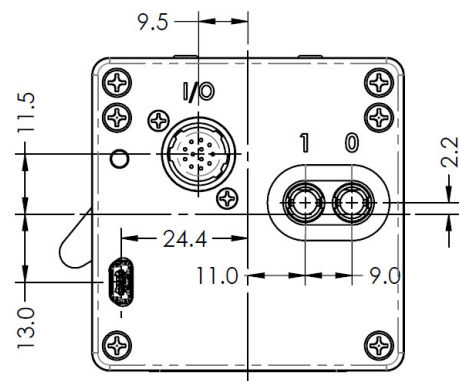

Top View:

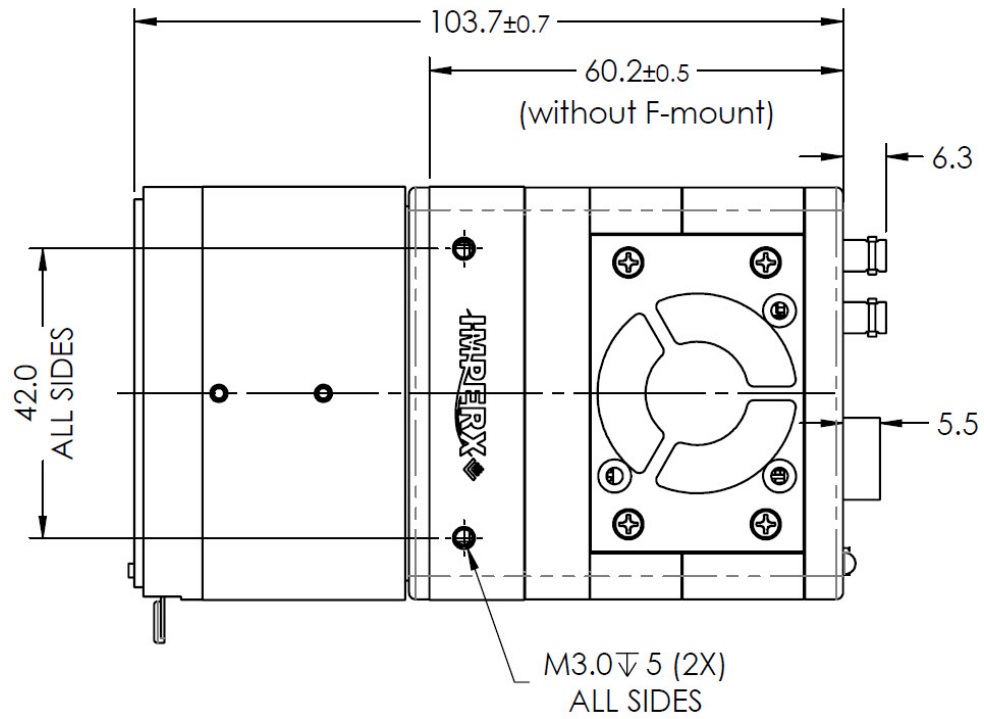

Side View with Image Plane:

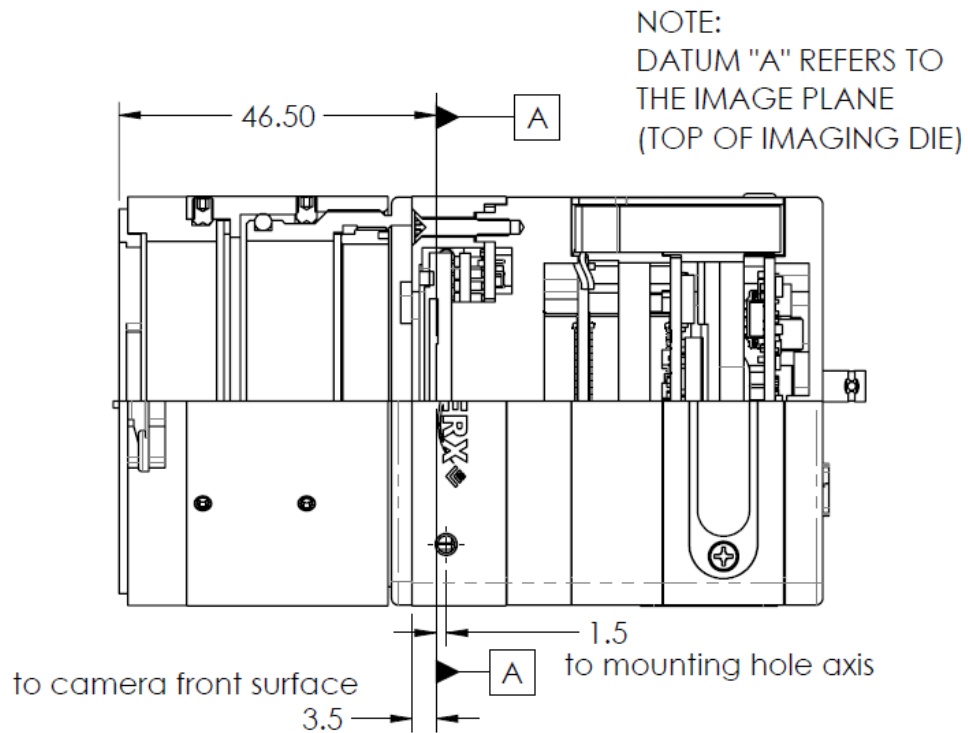

Mounting Plate

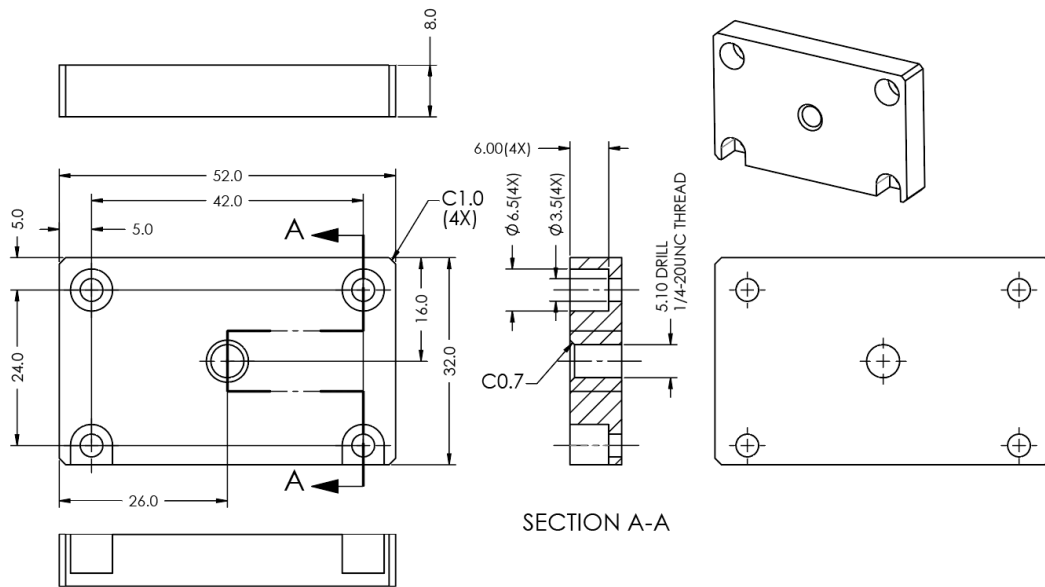

Optical

The Cheetah CoaXPress cameras come with an adapter for F-mount lenses that have a 46.50 mm back focal distance.

The camera can also be equipped with M42, Canon EF EOS Active or Passive mounts (refer to the section [Ordering Information](#)).

The camera is highly sensitive in the infrared (IR) spectral region. All color cameras have an IR cut-off filter installed. Monochrome cameras do not have any optical filter. If necessary, the monochrome camera can accommodate an IR filter (1 mm thickness or less) inserted under the front lens bezel.

CAUTION

Avoid direct exposure to a high intensity light source (such as a laser beam). This may damage the image sensor!

Avoid foreign particles on the surface of the image sensor.

TIP

Camera performance and signal to noise ratio (SNR) depend on the illumination (amount of light) reaching the sensor and the exposure time. Always try to balance these two factors. Unnecessarily long exposures increase the amount of dark noise and thus decrease the signal to noise ratio.

Environmental

Always keep the camera within temperature and humidity specifications listed below:

Specification	Definition
Operating temperature	-30 °C to +65 °C when the fan is On or Auto -30 °C to +50 °C when the fan is Off
Storage temperature	-40 °C to + 85 °C
Relative humidity	10% to 90%



Avoid direct exposure to moisture and liquids. The camera housing is not hermetically sealed and any exposure to liquids may damage the camera electronics!

Avoid operating the camera in the environment without any air circulation, near an intensive heat source, strong magnetic or electric fields.

Avoid touching or cleaning the front surface of the image sensor. If the sensor needs cleaning, use soft lint free cloth and an optical cleaning fluid.

Do not use methylated alcohol for cleaning the image sensor!

Please refer to the Sensor Cleaning Procedure document found on the camera's ZIP archive or contact Imperx support for cleaning procedures.

Handling the Camera

The fan assembly ASSY-5100-0027 is factory-installed. Replacement fans are available by contacting Imperx. Contact Imperx support for the CXP-C6440, C5440, C4440 Maintenance Procedures when replacing the fan.

CAUTION

When mounting the camera, make sure the inlet and outlet openings are not blocked by surrounding objects. The fan automatically turns on if the internal camera temperature exceeds 80 °C. Keep the fan inlets and outlet clear of obstructions.

Do not touch the camera for at least 20 minutes after shutting it down. Allow the camera to cool down. Hot surface may cause burns.

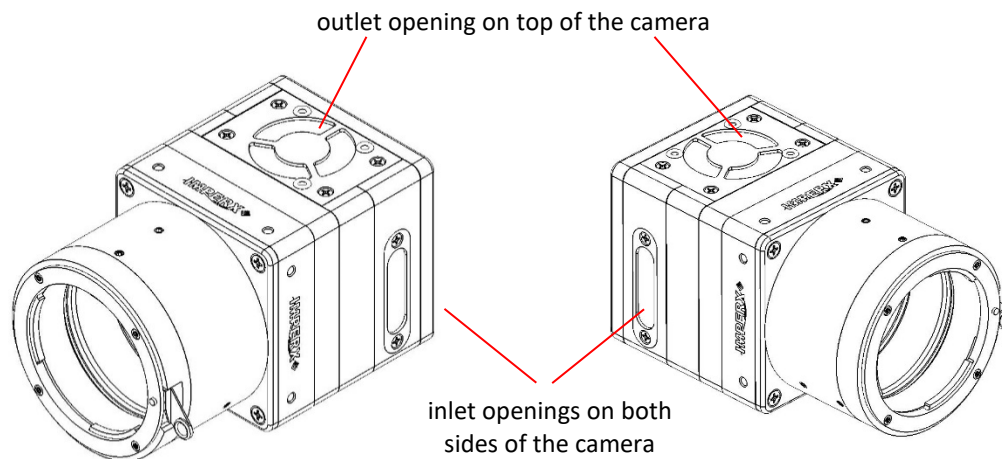

GenICam™ API Module – Configuring the Camera

Overview

Imperx Cheetah cameras are highly programmable and flexible. They allow control of all the camera's resources, camera settings, internal registers, video amplifiers, parameter flash, and so on. You communicate with the camera from a simple GenICam compliant graphical user interface (GUI). The GUI is bi-directional allowing you to issue commands to the camera and allowing the camera to issues responses (either status or information).

The CXP camera contains an XML parameters file enabling you to configure your camera's features and functions. The frame grabber normally provides software to view the camera's images and should also provide a GenICam compliant programming interface for configuring the camera.

Camera Startup

Upon powering up or receiving a DeviceReset command, the camera performs the following steps:

1. Boot loader checks program flash memory for a valid firmware image and loads it into the field-programmable gate array (FPGA).
2. The camera reads the Boot From register from the parameter Flash and loads a workspace from one of the configuration spaces determined by the User Set Default selector. The configuration spaces are: Factory Space (Default), User Space (User set 0–User Set 3).
3. The camera completes startup and accepts user commands.

GenApi Camera Configuration

The camera XML nodes are listed below with a description of the camera configuration parameters, the interface type, the range of control values, and the access mode for the parameter (RW: Read/Write, RO: Read Only, WO: Write Only).

NOTE (★) In the following tables, parameter names highlighted in *red italic* letters are changeable only if image acquisition is turned **off**. You cannot change these parameters if image acquisition is on. After making changes, you can turn the camera image acquisition back **on**.

Device Control Category

Device Control provides read-only information about the camera’s XML file and enables camera reset functionality.

DeviceControl	
DeviceVendorName	Imperx, inc.
DeviceModelName	CXP-C6440M-RF000
DeviceVersion	Version 1.0
DeviceFirmwareVersion	v002b016
DeviceManufacturerInfo	www.imperx.com
DeviceSerialNumber	1180000
DeviceUserID	User def. name
DeviceSFNCVersionMajor	2
DeviceSFNCVersionMinor	3
DeviceSFNCVersionSubMinor	0
DeviceScanType	Areascan
DeviceReset	Execute
CameraHeadReset	Execute
DeviceTemperatureSelector	Sensor
DeviceTemperature	21.66

Parameter Name	Type	Value	Access	Description
DeviceVendorName	String		RO	Provides the name of the manufacturer of the camera
DeviceModelName	String		RO	Provides the model of the device
DeviceVersion	String		RO	Provides the version of the camera
DeviceFirmwareVersion	String		RO	Provides firmware version of the camera
DeviceManufacturerInfo	String		RO	Provides extended manufacturer information about the camera
DeviceSerialNumber	String		RO	Provides serial number of the camera
DeviceUserID	String		RW	Provides user defined name of the device
DeviceSFNCVersionMajor	Integer		RO	Major version of SFNC used for XML.
DeviceSFNCVersionMinor	Integer		RO	Minor version of SFNC used for XML

Parameter Name	Type	Value	Access	Description	
DeviceSFNCVersionSubMinor	Integer		RO	Sub-minor version of SFNC used for XML.	
DeviceScanType	Enumeration	String Areascan	Num. 0	RO	Specifies the scan type of the sensor.
DeviceReset	Command		WO	Resets camera to power-up state (resets both the CXP Engine and the camera head).	
CameraHeadReset	Command		WO	Resets the camera circuitry. The CXP Engine does not reset. NOTE: After camera reset, issue a <u>UserSetLoad</u> command.	
DeviceTemperatureSelector	Enumeration	String Sensor Mainboard SensorBoard FPGA	Num. 0 1 2 3	RW	Selects the location within the device where the temperature will be measured.
DeviceTemperature	Float		RO	Returns the current temperature in degrees Celsius (°C) measured at the location selected by <i>DeviceTemperatureSelector</i> .	

Device Control – Temperature Control

Temperature Control allows you to set the fan’s operation mode and the temperature at which the fan turns on in Auto mode.

NOTE (*) The fan automatically turns on—even if the fan operation mode is Off—when the internal camera temperature exceeds 80 °C.

TemperatureControl	
FanMode	Auto
FanOnTemperature	50

Parameter Name	Type	Value	Access	Description	
FanMode	Enumeration	String	Num.	RW	Sets the operation mode of the camera fan.
		Off	0		
		On	1		
		Auto	2		
FanOnTemperature	Float		RW	Sets the temperature, in Celsius degrees, when the camera fan turns on to cool the camera (in Auto mode). Fan turns off when the internal camera temperature is 4 °C below the set temperature.	

Version Information Category

Version Information provides read-only information identifying the camera’s firmware, hardware, software, image sensor, camera version, CXP support, and so on. This information is programmed during the manufacturing process and stored in non-volatile memory.

VersionInfo	
SensorType	Bayer
SensorModel	IMX367LQ
RgsID	0x6000
FirmwareImage	0xA
CameraHeadFirmwareVersion	0x1
CameraHeadFirmwareBuild	51
CustomerID	0
FamilyID	20
XmlVersion	0x10005

Parameter Name	Type	Value	Access	Description
SensorType	Enumeration	String Monochrome Bayer	Num. 0 1	RO Returns the CMOS sensor type.
SensorModel	Enumeration	String Unknown IMX342LQ IMX342LL IMX367LQ IMX367LL IMX387LQ IMX387LL	Num. 0 0x00000156 0x00000556 0x0000016F 0x0000056F 0x00000183 0x00000583	RO Returns the CMOS model name.
RgsID	Integer			RO Returns RGS ID.
FirmwareImage	Integer			RO Returns the Firmware Image ID (F=Factory or A= Application)
CameraHeadFirmwareVersion	Integer			RO Returns the Camera Head Firmware Version Number
CameraHeadFirmwareBuild	Integer			RO Returns Firmware build Number
CustomerID	Integer			RO Returns Customer ID for custom cameras (0 = Imperx Standard camera)
FamilyID	Integer			RO Returns Camera Family ID
XMLVersion	Integer			RO Returns XML Version

CXP Support Category

The CXP Support category includes registers needed to support other standards, such as GenICam.

CxpSupport	
Standard	0x0
Revision	0x10001
XmlManifestSize	1
XmlManifestSelector	0
XmlSchemaVersion	0x10001
XmlUrlAddress	0x30000000
IidcPointer	0

Parameter Name	Type	Value	Access	Description
Standard	Integer		RO	Returns CoaXPress “magic” number.
Revision	Integer		RO	Returns revision of CoaXPress specification implemented in the camera.
XmlManifestSize	Integer		RO	Returns number of XML manifests available in the camera.
XmlManifestSelector	Integer		RO	Returns number of the selected XML manifest.
XmlSchemaVersion	Integer		RO	Returns GenICam schema version of the XML.
XmlUrlAddress	Integer		RO	Returns address of start of the URL string that points to the XML file.
IidcPointer	Integer		RO	Returns address of the start of the IIDC register space

Troubleshooting Category

▼ Troubleshooting	
slvsecStatus	Sync
slvsecSyncState	Finished

Parameter Name	Type	Value	Access	Description	
slvsecStatus	Enumeration	String	Num.	RO	Shows SLVCEC status.
		NoSync	0		
		Sync	1		
slvsecSyncState	Enumeration	String	Num.	RO	Shows SLVCEC sync state.
		WaitSync	0		
		WaitEmpty	1		
		SyncCode	2		
		WaitIdle	3		
		StateSync	4		
		Finished	5		

Image Format Control Category

Image Format Control lets you change screen resolution, select pixel format, and more.

Image Format Control	
SensorWidth	4432
SensorHeight	4436
WidthMax	4416
HeightMax	4436
Width	4416
Height	4436
OffsetX	0
OffsetY	0
PixelFormat	Mono8
PixelSize	Bpp8
Pixel Color Filter	None
BinningVerticalMode	Sum
BinningVertical	1
BinningHorizontalMode	Sum
BinningHorizontal	1
DecimationVertical	1
DecimationHorizontal	1
ReverseX	<input type="checkbox"/> False
ReverseY	<input type="checkbox"/> False
TestPattern	Off
SensorTestPattern	Off
ADC Bit Depth	10 Bit
SensorShutterMode	Global

Parameter Name	Type	Value	Access	Description
SensorWidth	Integer		RO	Returns effective width of sensor in pixels.
SensorHeight	Integer		RO	Returns effective height of sensor in pixels.
WidthMax	Integer		RO	Returns max. width of image in pixels calculated after horizontal binning, decimation, or other functions are applied.
HeightMax	Integer		RO	Returns max. height of image in pixels calculated after vertical binning, decimation, or other functions are applied.

Parameter Name	Type	Value	Access	Description	
<i>Width</i>	Integer	Min: Depends on <i>PixelFormat</i> Max: Depends on camera model	RW	Represents actual image output width of master AOI (in pixels).	
<i>Height</i>	Integer	Min: Depends on <i>PixelFormat</i> Max: Depends on camera model	RW	Represents actual image output height of master AOI (in pixels).	
OffsetX	Integer	Min: 0 Max: Depends on <i>Width</i>	RW	Horizontal offset from origin to area of interest (in pixels).	
OffsetY	Integer	Min: 0 Max: Depends on <i>Height</i>	RW	Vertical offset from origin to area of interest (in pixels).	
<i>PixelFormat</i>	Enumeration	String Mono8 Mono10 Mono12 BayerGR8 BayerRG8 BayerGB8 BayerBG8 BayerGR10 BayerRG10 BayerGB10 BayerBG10 BayerGR12 BayerRG12 BayerGB12 BayerBG12	Num. 0x01080001 0x01100003 0x01100005 0x01080008 0x01080009 0x0108000A 0x0108000B 0x0110000C 0x0110000D 0x0110000E 0x0110000F 0x01100010 0x01100011 0x01100012 0x01100013	RW	Sets Output Data Pixel format.
<i>PixelSize</i>	Enumeration	String Bpp8 Bpp10 Bpp12	Num. 0 1 2	RO	Total size in bits of a pixel of the image.
<i>PixelColorFilter</i>	Enumeration	String None BayerRG BayerGB BayerGR BayerBG	Num. 0 1 2 3 4	RO	Returns type of color filter that is applied to the image.
BinningVerticalMode ¹	Enumeration	String Sum	Num. 0	RO	Returns the mode used to combine horizontal photo-sensitive cells together when <i>BinningVertical</i> is used.
<i>BinningVertical</i>	Integer	Min: 1 Max: 2	RW	Number of vertical photo-sensitive cells to combine. This reduces the vertical resolution (height) of the image	

Parameter Name	Type	Value	Access	Description	
BinningHorizontalMode ¹	Enumeration	String Sum	Num. 0	RO	Returns the mode used to combine horizontal photo-sensitive cells together when <i>Binning Horizontal</i> is used.
<i>BinningHorizontal</i>	Integer	Min: 1 Max: 2		RW	Number of horizontal photo-sensitive cells to combine. This reduces the horizontal resolution (width) of the image.
<i>DecimationVertical</i>	Integer	Min: 1 Max: 2		RW	Vertical sub-sampling of the image. This reduces the vertical resolution (height) of the image by the specified vertical decimation factor.
<i>DecimationHorizontal</i>	Integer	Min: 1 Max: 2		RW	Horizontal sub-sampling of the image. This reduces the horizontal resolution (width) of the image by the specified horizontal decimation factor.
<i>ReverseX</i> ²	Boolean			RW	Horizontally flips the image output. Any area of interest is applied after the flipping. The <i>PixelFormat</i> of color cameras changes automatically.
<i>ReverseY</i> ²	Boolean			RW	Vertically flips the image output. Any area of interest is applied after the flipping. The <i>PixelFormat</i> of color cameras changes automatically.
TestPattern ³	Enumeration	String Off GreyHorizontalRamp GreyVerticalRamp GreyHorizontalRampMoving GreyVerticalRampMoving FlatField	Num 0 1 2 3 4 5	RW	Selects type of test pattern generated by the camera replacing the image sensor as the source (refer to section Test Image Pattern for more information).
<i>SensorTestPattern</i> ⁴	Enumeration	String Off Mode0 Mode1	Num 0 1 2	RW	Selects the type of test pattern that is generated by the camera image sensor. Mode0 and Mode1 are

Parameter Name	Type	Value	Access	Description
				used to verify the sensor's connectivity to an FPGA.
AdcBitDepth	Enumeration	String Bit10 Bit12	Num RO 10 12	Returns which ADC bit depth is used. A higher ADC bit depth results in better image quality but slower maximum frame rate.
SensorShutterMode	Enumeration	String Global	Num RO 1	Returns the shutter mode of the device.

¹**BinningHorizontal/Vertical Mode** values:

- **Sum**:The response from the combined cells will be added, resulting in increased sensitivity.

NOTE (*) Currently, the camera performs the **Sum** mode only.
To enable binning feature, set *BinningHorizontal* or *BinningVertical* to 2.
The binning is disabled when *DecimationVertical* or *DecimationHorizontal* is enabled, and vice versa.

²When *ReverseX* and/or *ReverseY* are enabled for a color camera, the *PixelFormat* changes automatically according to the current Bayer pattern start pixel:

Original *PixelFormat*: BayerRG8



ReverseX is enabled
New *PixelFormat*: BayerGR8



ReverseY is enabled
New *PixelFormat*: BayerGB8



ReverseX and *ReverseY* are enabled together
New *PixelFormat*: BayerBG8

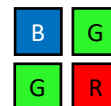

³**Test Pattern** values:

Off: Image is coming from the sensor

GreyHorizontalRamp: Image is filled horizontally with a digital pattern that goes from the darkest possible value to the brightest.

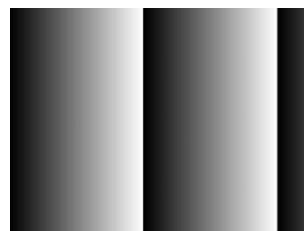

GreyVerticalRamp: Image is filled vertically with a digital pattern that goes from the darkest possible value to the brightest.



GreyHorizontalRampMoving: Image is filled horizontally with digital pattern that goes from the darkest possible value to the brightest and that moves horizontally from left to right at each frame.

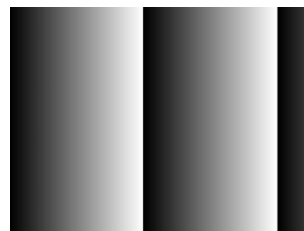

GreyVerticalRampMoving: Image is filled vertically with digital pattern that goes from the darkest possible value to the brightest and that moves vertically from top to bottom at each frame.



FlatField: Displays a constant grey level for all display pixels.



⁴**Sensor Test Pattern** values:

Mode0: The sensor test image is filled with a vertical stripe pattern of one pixel width. Values are:
12-bit: FFFh/555h/AAAh/000h
10-bit: 3FFh/155h/2AAh/000h
8-bit: FFh/55h/Aah/00h

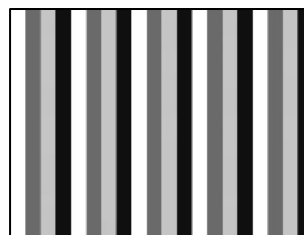

This ensures that the connection between the sensor and FPGA is synchronized.

*For color cameras, make sure that *BalanceRatio* is set to 1.0 and *BalanceWhiteAuto* is Off.

Mode1: The sensor test image is filled horizontally with digital pattern that goes from the darkest possible value to the brightest.
This ensures that the connection between the sensor and FPGA is synchronized.

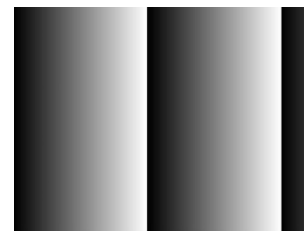

Acquisition Control Category

Acquisition Control lets you configure settings for image capture, exposure, frame rates, triggers, and so on. It also provides read-only information on frame and exposure time.

AcquisitionControl	
AcquisitionMode	Continuous
AcquisitionStart	Execute
AcquisitionStop	Execute
ExposureMode	Timed
ExposureTime	5,277
ExposureAuto	Off
AcquisitionFrameRateEnable	<input type="checkbox"/> False
AcquisitionFrameTime	25225
AcquisitionFrameRate	39.64
AcquisitionLineTimeEnable	<input type="checkbox"/> False
AcquisitionLineTime	414
AcquisitionBurstFrameCount	1
CurrentExposureTime	5277
CurrentFrameTime	25225
TriggerMode	Off
TriggerSoftware	Execute
TriggerSource	Line1
TriggerActivation	RisingEdge
TriggerOverlap	Off
TriggerDebounceTime	0
TriggerFilterTime	0
TriggerDelay	0

Parameter Name	Type	Value	Access	Description
AcquisitionMode	Enumeration	String Continuous	Num. RO 0	Defines the number of frames to capture during acquisition and the way the acquisition stops
AcquisitionStart	Command		WO	Starts device acquisition.
AcquisitionStop	Command		WO	Stops acquisition after current frame completes readout.
<i>ExposureMode</i> ¹	Enumeration	String Off Timed TriggerWidth	Num. RW 0 1 2	Sets exposure mode (refer to Exposure Control for more information).

Parameter Name	Type	Value	Access	Description
<i>ExposureTime</i> ²	Float		RW	Sets Timed Exposure in microseconds when <i>ExposureMode</i> is Timed and <i>ExposureAuto</i> is Off.
ExposureAuto	Enumeration	String Off Once Continuous	Num. 0 1 2 RW	Sets the automatic exposure mode when <i>ExposureMode</i> is Timed.
<i>AcquisitionFrameRateEnable</i>	Boolean		RW	Controls if the <i>AcquisitionFrameRate</i> and <i>AcquisitionFrameTime</i> features are writable and used to control the acquisition rate. If On, you can extend the actual frame time beyond the free-running frame time. Trigger is disabled and cannot be used in combination with this feature.
<i>AcquisitionFrameTime</i>	Integer		RW	Sets Frame Time in microseconds.
<i>AcquisitionFrameRate</i>	Float		RW	Controls acquisition rate (in Hz) of frames captured.
<i>AcquisitionLineTimeEnable</i>	Boolean		RW	Controls if the <i>AcquisitionLineTime</i> feature are writable and used to control the acquisition line time.
<i>AcquisitionLineTime</i>	Integer		RW	This feature sets the actual line time in pixel clocks (74.25MHz).
<i>AcquisitionBurstFrameCount</i>	Integer	Min: 1 Max: 65535	RW	Number of frames to acquire for each trigger.
CurrentExposureTime	Integer		RO	Returns current exposure time in microseconds.
CurrentFrameTime	Integer		RO	Returns current frame time in microseconds.
<i>TriggerMode</i>	Enumeration	String Off On	Num. 0 1 RW	Enables Trigger mode of operation. Not available if <i>AcquisitionFrameRateEnable</i> parameter is On.
TriggerSoftware	Command		WO	Generates internal trigger. <i>TriggerSource</i> must be set to Software.

Parameter Name	Type	Value	Access	Description
<i>TriggerSource</i> ³	Enumeration	String	Num. RW	Specifies internal signal or external Line as trigger source. <i>TriggerMode</i> must be set to On (refer to Trigger Sources for more information).
		Line1	0	
		Line2	1	
		LinkTrigger	2	
		PulseGenerator	4	
Software	5			
<i>TriggerActivation</i>	Enumeration	String	Num. RW	Specifies activation edge of trigger.
		RisingEdge	0	
		FallingEdge	1	
<i>TriggerOverlap</i>	Enumeration	String	Num. RW	Specifies the trigger overlap mode, if the camera receives a trigger pulse while processing the previous trigger. Off – Standard Trigger mode; ReadOut – Fast Trigger mode.
		Off	0	
		ReadOut	1	
<i>TriggerDebounceTime</i>	Integer	Min: 0 Max: 65535	RW	Specifies time period (in microseconds) when a second trigger is not accepted.
<i>TriggerFilterTime</i>	Integer	Min: 0 Max: 65535	RW	Specifies the minimum Trigger signal pulse width. Any pulse shorter than the selected time is ignored.
<i>TriggerDelay</i>	Integer	Min: 0 Max: 16000000	RW	Specifies delay between trigger and start of exposure (in microseconds).

¹**Exposure Mode** values:

- **Off** – Disables the Exposure. The exposure time is equal to frame time.
- **Timed** – The exposure duration is set by the *ExposureTime* or *ExposureAuto* features.
- **TriggerWidth** – The exposure duration is set by the width of the current trigger signal pulse. Note that if *TriggerActivation* is set to *RisingEdge*, the exposure duration will be the time the trigger stays high. If *TriggerActivation* is set to *FallingEdge*, the exposure time lasts as long as the trigger stays low.

²**ExposureTime** – The maximum exposure time is equal to the frame time. For longer exposure times, increase the frame period using the *AcquisitionFrameTime* or *AcquisitionFrameRate* features.

³**TriggerSource** values:

- **Line1** –Hardware Input Line GP Input 1 (TRIGGER 1) is used as external source for the trigger signal.
- **Line2** –Hardware Input Line GP Input 2 (TRIGGER 2) is be used as external source for the trigger signal.
- **LinkTrigger** – CXP Link Trigger is used as source for the trigger signal (received from the CXP transport layer).

- **PulseGenerator** – Specifies that the trigger source will be generated by camera’s internal Pulse Generator.
- **Software** – Specifies that the trigger source will be generated by software using the TriggerSoftware command.

Analog Control Category

Analog Control provides parameters for configuring gain, black level, gamma correction, and auto white balance.

▼ AnalogControl	
Gain	3.000000
GainAuto	Off
BlackLevel	60.000000
SensorBlackLevelRecomended	<input checked="" type="checkbox"/> True
BlackLevelAuto	Continuous
Gamma	1.000000
DigitalGain	1.000000
DigitalBlackLevel	0.000000
▼ BalanceRatioSelector	Red
BalanceRatio	1.000000
BalanceWhiteAuto	Off

Parameter Name	Type	Value	Access	Description
Gain	Float	Min: 0.0 Max: 48.0	RW	Controls the selected gain as an absolute physical value. This is an amplification factor applied to the video signal.
GainAuto	Enumeration	String Off Once Continuous	Num. 0 1 2	RW Sets the automatic gain control (AGC) mode. ExposureMode can be set to Timed, PulseWidth, or Off.
BlackLevel	Float	Min: 0.0 Max: 4095.0	RW	Controls the on-sensor analog black level as an absolute physical value. This represents a DC offset applied to the video signal.
SensorBlackLevelRecomended	Boolean		RW	Uses recommended value of <i>BlackLevel</i> from the sensor
BlackLevelAuto	Enumeration	String Off Continuous	Num. 0 1	RW Sets the on-sensor mode for automatic black level adjustment
Gamma	Float	Min: 0.00 Max: 4.00	RW	Controls the gamma correction of pixel intensity with an increment of 0.01.

Parameter Name	Type	Value	Access	Description
DigitalGain	Float	Min: 0.0 Max: 4.0	RW	Controls the Digital Gain for all taps.
DigitalBlackLevel	Float	Min: -4096.0 Max: 4095.0	RW	Controls the Digital Black Level for all taps.
BalanceRatioSelector	Enumeration	String Red Blue	Num. 0 1	RW White Balance Control: Selects which color will be impacted by the <i>BalanceRatio</i> control.
BalanceRatio	Float	Min: 0.25 Max: 4.00	RW	White balance color ratio. Controls ratio of the selected color component to green, which is the reference color. If the Red and Blue Balance ratios are manually set to 1.0, no white balance correction is applied to the pixels.
BalanceWhiteAuto	Enumeration	String Off Once Continuous	Num. 0 1 2	RW Controls the mode for automatic white balancing between the color channels. The white balancing color ratios are automatically adjusted by selecting either Once or Continuous. If Off, the White Balance color ratios are set manually using <i>BalanceRatioSelector</i> and <i>BalanceRatio</i> controls.

Data Correction Category

Data Correction parameters enable you to implement look-up tables and other techniques to improve performance.

DataCorrection	
LUTEnable	Off
FFCEnable	FactoryFFC
DefectPixelCorrection	Factory
DefectPixelCorrectionMode	Average
BadPixelCorrection	Factory
BadPixelCorrectionMode	Average
DefectPixelCountMax	1024
BadPixelCountMax	4096

Parameter Name	Type	Value	Access	Description
LUTEnable	Enumeration	String Off	Num. RW 0	Selects and enables LUT to be used in processing image. (LUT1 and LUT3 are preprogrammed with Gamma 0.45, LUT 2 and LUT 4 – with negative LUT)
		LUT1	1	
		LUT2	2	
		LUT3	3	
		LUT4	4	
FFCEnable	Enumeration	String Off	Num. RW 0	Selects FFC to be used in processing image.
		FactoryFFC	1	
		FFC1	2	
		FFC2	3	
		FFC3	4	
		FFC4	5	
		FFC5	6	
		FFC6	7	
FFC7	8			
DefectPixelCorrection	Enumeration	String Off	Num. RW 0	Enables defect pixel correction. You can upload your own defect pixel map.
		Factory	1	
		User	2	
DefectPixelCorrectionMode ¹	Enumeration	String Average	Num. RW 0	Controls the method used for replacing defective pixels (Highlight and Zero are for testing purposes only)
		Highlight	1	
		Zero	2	
BadPixelCorrection	Enumeration	String Off	Num. RW 0	Enables Hot Pixel Correction. You can upload your own hot pixel map.
		Factory	1	
		User	2	
BadPixelCorrectionMode ¹	Enumeration	String Average	Num. RW 0	Controls the method used for replacing hot pixels (Highlight and Zero are for testing purposes only).
		Highlight	1	
		Zero	2	

Parameter Name	Type	Value	Access	Description
DefectPixelCountMax	Integer		RO	Maximum number of pixels in the Defect Pixel Correction Table.
BadPixelCountMax	Integer		RO	Maximum number of pixels in the Hot Pixel Correction Table.

¹**DefectPixelCorrectionMode** and **BadPixelCorrectionMode** values:

- **Average** – Defective or Hot Pixels are replaced with the average of their neighbors.
- **Highlight** – Defective or Hot Pixels are replaced with the maximum pixel value.
- **Zero** – Defective or Hot Pixels are replaced by the value zero.

Auto White Balance, Exposure and Gain Algorithm Control Category

Auto Algorithm Control lets you configure settings for AWB (Automatic White Balance), AEC (Automatic Exposure Control), and AGC (Automatic Gain Control) algorithms.

You can set the camera to AEC/AGC to keep the same image brightness during changing lighting conditions. On the Auto Algorithm Control panel, you can configure the range of exposure times and gain values for AEC/AGC by placing minimum and maximum limits on these parameters.

AutoAlgorithmControl	
BalanceWhiteAutoLowerLimit	0.250000
BalanceWhiteAutoUpperLimit	4.000000
BalanceWhiteAutoSpeed	64
ExposureAutoLowerLimit	50
ExposureAutoUpperLimit	25,000
GainAutoLowerLimit	0.000000
GainAutoUpperLimit	48.000000
ExposureGainAutoPriority	ExposureTime
ExposureGainAutoMode	Average
ExposureGainAutoTarget	1500
ExposureGainAutoTargetThreshold	16
AverageLuminosity	1485
CurrentFrameCounterLow	1921
CurrentFrameCounterHigh	0

Parameter Name	Type	Value	Access	Description
BalanceWhiteAutoLowerLimit	Float	Min: 0.25 Max: BalanceWhiteAutoUpperlimit	RW	Controls the minimum value AWB can set for the Red/Blue <i>BalanceRatio</i> .
BalanceWhiteAutoUpperLimit	Float	Min: BalanceWhiteAutoLowerlimit Max: 4.0	RW	Controls the maximum value AWB can set for the Red/Blue <i>BalanceRatio</i> .
BalanceWhiteAutoSpeed	Integer	Min: 1 Max: 64	RW	Speed of AWB algorithm. 1= slowest, 64 is fastest.
ExposureAutoLowerLimit	Float	Min: ExposureTimeMin Max: ExposureAutoUpperLimit	RW	The shortest exposure time that Auto Exposure can set

Parameter Name	Type	Value	Access	Description
ExposureAutoUpperLimit	Float	Min: ExposureAutoLowerLimit Max: ExposureTimeMax	RW	The longest exposure time that Auto Exposure can set.
GainAutoLowerLimit	Float	Min: 0.0 Max: GainAutoUpperLimit	RW	The lowest gain that Auto Gain can set.
GainAutoUpperLimit	Float	Min: GainAutoLowerLimit Max: 48.0	RW	The highest gain that Auto Gain can set.
ExposureGainAutoPriority	Enumeration	String Gain ExposureTime	Num. 0 1 RW	Selects whether to adjust gain or exposure first.
ExposureGainAutoMode	Enumeration	String Average	Num. 0 RO	Shows what luminance mode is used during AGC or AEC.
ExposureGainAutoTarget	Integer	Min: 1 Max: 4095	RW	Sets the desired luminance level to be maintained during AGC or AEC.
ExposureGainAutoTargetThres hold	Integer	Min: 0 Max: 4095	RW	Sets the acceptable steady-state error of the luminance level to be maintained during AGC or AEC. Normal initial setting for stability is 16.
AverageLuminosity	Integer		RO	Shows average luminosity of the image.
CurrentFrameCounterLow	Integer		RO	Shows number of frames captured since the camera power up (lower 32 bits).
CurrentFrameCounterHigh	Integer		RO	Shows number of frames captured since the camera power up (upper 32-bits).

Exposure Auto PID Coefficients Category



We do not recommend changing min and max limits of the P coefficient. Doing so may cause oscillations and destabilize a PID controller. Imperx sets up optimal values to balance the speed and stability of the AEC algorithm.

If you need to change the P coefficient, please contact Imperx support.

ExposureAutoPIDCoefficients	
ExposureAutoPMin	0.040000
ExposureAutoPMax	8.000000
ExposureAutoExposureForPMax	25,000

Parameter Name	Type	Value	Access	Description
ExposureAutoPMin	Float	Min: 0.0 Max: 256.0	RW	Controls the minimum of the P coefficient for Exposure Auto control loop.
ExposureAutoPMax	Float	Min: 0.0 Max: 256.0	RW	Controls the maximum of the P coefficient for Exposure Auto control loop.
ExposureAutoExposureForPMax	Float	Min: ExposureTimeMin Max:	RW	Maps the maximum of the P coefficient to the value of exposure in the Exposure Auto control loop.

Please refer to the section [P, I, and D Coefficients](#) for more information.

Gain Auto PID Coefficients Category



We do not recommend changing the P, I, and D coefficients. Doing so may cause oscillations and destabilize a PID controller. Imperx sets up optimal values to balance the speed and stability of the AGC algorithm.

If you need to change the P, I, and D coefficients, please contact Imperx support.

GainAutoPIDCoefficients	
GainAutoPcoef	0.060000
GainAutoIcoef	0.000000
GainAutoDcoef	0.030000

Parameter Name	Type	Value	Access	Description
GainAutoPcoef	Float	Min: 0.0 Max: 256.0	RW	Controls the P coefficient for Gain Auto control loop.
GainAutoIcoef	Float	Min: 0.0 Max: 256.0	RW	Controls the I coefficient for Gain Auto control loop.
GainAutoDcoef	Float	Min: 0.0 Max: 256.0	RW	Controls the D coefficient for Gain Auto control loop.

Please refer to the section [P, I, and D Coefficients](#) for more information.

Digital Input / Output Control Category

Digital Input / Output Control allows you to map camera’s inputs and outputs and configure strobes.

▼ DigitalIOControl	
▼ LineSelector	Input1
LineMode	Input
LineInverter	<input type="checkbox"/> False
LineStatus	<input type="checkbox"/> False
LineSource	Off
LineFormat	OptoCoupled
Strobe1Reference	Exposure
Strobe1Enable	On
Strobe1Width	1000
Strobe1Delay	10
Strobe2Reference	Exposure
Strobe2Enable	On
Strobe2Width	1000
Strobe2Delay	10

Parameter Name	Type	Value	Access	Description
LineSelector	Enumeration	String Input1 Input2 Output1 Output2	Num. 0 1 2 3	RW Selects the physical line (or pin) of the external camera connector or the virtual line of the Transport Layer to configure.
<i>LineMode</i>	Enumeration	String Input Output	Num. 0 1	RO Returns the status of the physical line used to input or output a signal.
<i>LineInverter</i>	Boolean			RW Controls the inversion of the signal of the selected input or output line.
LineStatus	Boolean	logic 1 – true logic 0 – false		RO Returns the current signal level on the selected input or output line.
<i>LineSource</i> ¹	Enumeration	String Off ExposureStart ExposureEnd MidExposure ExposureActive TriggerActual TriggerDelayed PulseGenerator Strobe1 Strobe2	Num. 0 1 2 3 4 5 6 7 8 9	RW Selects which internal signal to output on the selected line. <i>LineSelector</i> must be set to Output.

Parameter Name	Type	Value	Access	Description
<i>LineFormat</i> ²	Enumeration	String NoConnect TriState TTL OptoCoupled	Num. 0 1 2 3	RO Returns the current electrical format of the selected physical input or output line.
Strobe1Reference	Enumeration	String Start of Exposure Start of Readout Trigger	Num. 0 1 2	RW Sets the reference event for Strobe #1 signal.
Strobe1Enable	Enumeration	String Off On	Num. 0 1	RW Enables or disables the Strobe #1.
Strobe1Width	Integer	Min: 10 Max: Depends on CurrentFrameTime and Strobe1Delay	RW	Sets Strobe #1 pulse duration in microseconds. The maximum strobe width equals frame period. Maximum possible value is 16 s.
Strobe1Delay	Integer	Min: 0 Max: Depends on CurrentFrameTime and Strobe1Width	RW	Sets Strobe #1 delay from the reference, in microseconds. The maximum strobe delay equals frame period. Maximum possible value is 16 s.
Strobe2Reference	Enumeration	String Start of Exposure Start of Readout Trigger	Num. 0 1 2	RW Sets the reference event for Strobe #2 signal.
Strobe2Enable	Enumeration	String Off On	Num. 0 1	RW Enables or disables the Strobe #2.
Strobe2Width	Integer	Min: 10 Max: Depends on CurrentFrameTime and Strobe2Delay	RW	Sets Strobe #2 pulse duration in microseconds. The maximum strobe width equals frame period. Maximum possible value is 16 s.
Strobe2Delay	Integer	Min: 0 Max: Depends on CurrentFrameTime and Strobe2Width	RW	Sets Strobe #2 delay from the reference, in microseconds. The maximum strobe delay equals frame period. Maximum possible value is 16 s.

¹**LineSource** values for Outputs only

- **ExposureStart** – A short pulse indicating the beginning of the exposure.
- **ExposureEnd** – A short pulse indicating the end of the exposure.
- **MidExposure** – A short pulse indicating the middle of the exposure.
- **ExposureActive** – The output signal is active for the duration of exposure time.
- **TriggerActual** – Maps the input trigger pulse to the output with no delay.
- **TriggerDelayed** – Maps the input trigger pulse to the output with trigger delay.

- **PulseGenerator** – Maps the internal pulse generator waveform to the output.
- **Strobe1** – Maps the Strobe 1 signal to the corresponding external output.
- **Strobe2** – Maps the Strobe 2 signal to the corresponding external output.

²**LineFormat** values:

- **NoConnect** – The line is not connected.
- **TriState** – The line is currently in Tri-State mode (Not driven).
- **TTL** – The line is currently accepting or sending TTL level signals.
- **OptoCoupled** – The line is opto-coupled.

Depending on line selected under *LineSelector* (Input or Output), you can apply the following controls:

LineSelector	Available controls	Values
Input1 or Input2	<i>LineInverter</i>	True False
Output1 or Output2	<i>LineInverter</i>	True False
	<i>LineSource</i>	Off ExposureStart ExposureEnd MidExposure ExposureActive TriggerActual TriggerDelayed PulseGenerator Strobe1 Strobe2

You also can monitor the current logic level (1 or 0) of the signal on the selected input or output by using the *LineStatus* parameter.

The *LineMode* parameter shows the status of the selected input or output line.

Pulse Generator Category

The camera provides an internal pulse generator for generating a trigger signal. You can program it to generate a discrete sequence or a continuous trail of pulse signals.

PulseGenerator	
PulseGenGranularity	x1uS
PulseGenWidth	1000
PulseGenPeriod	50000
PulseGenNumPulses	1
PulseGenMode	Continuous
PulseGenEnable	<input type="checkbox"/> False

Parameter Name	Type	Value	Access	Description
PulseGenGranularity	Enumeration	String x1uS x10uS x100uS x1000uS	Num. 0 1 2 3	RW Sets the multiplication factors of the Pulse Generator where x1 = 1 μS, x10=10 μS, etc.
PulseGenWidth	Integer		RW	Sets pulse width of Pulse Generator where each unit is equal to <i>PulseGenGranularity</i> .
PulseGenPeriod	Integer		RW	Sets pulse period of Pulse Generator where each unit is equal to <i>PulseGenGranularity</i> .
PulseGenNumPulses	Integer	Min: 1 Max: 65536	RW	Sets number of pulses to be generated by Pulse Generator.
PulseGenMode	Enumeration	String Continuous NumPulses	Num. 0 1	RW Sets the mode of the Pulse Generator.
PulseGenEnable	Boolean		RW	Enables Pulse Generator. The pulse generator output can be mapped to the OUTPUT1 or OUTPUT2 output signals. It also can be used as a trigger source.

Canon Lens Control Category

Canon EF Lens provides motorized iris and focus (not zoom) features. Canon Lens Control parameters give you control over the iris and focus position. Refer to section [Canon Lens Control](#) for more information on lens adjusting procedures.

Controller Settings Category

▼ CanonLensControl	
▼ ControllerSettings	
InitLens	Execute
StopLens	Execute
LensControllerStatus	InitLens_Done
LensAF_MF	AutoFocus
GetLensID	Execute
LensID	0x813C

Parameter Name	Type	Value	Access	Description	
InitLens	Command		WO	Initializes the Canon Lens. Always initialize lens after power up.	
StopLens	Command		WO	Removes the power from the Iris drive. Run the <i>InitLens</i> command to resume the lens control.	
LensControllerStatus	Enumeration	String InitLens_Failed InitLens_Done	Num. 0 1	RO	Shows status of Canon Lens initialization.
LensAF_MF	Enumeration	String AutoFocus ManualFocus	Num. 0 1	RW	Shows status of Auto/Manual focus switch located on the lens.
GetLensID	Command			WO	Requests value of Lens ID register.
LensID	Integer			RO	Returns Lens ID after the <i>GetLensID</i> command is issued.

Focus Category

Using the *Focus NearStep* and *FarStep* features, you can focus the lens manually. After reading the *FocusEncoderStatus*, you can program the *FocusReqPosition* feature with the focus encoder value and then return to this focus position using the *SetFocusPosition* command.

The *Focus Max* register sets an upper limit for the *FocusReqPosition*. Use the *GetFocusEncoder* command to read the maximum focus encoder position. Then use the *FocusSetMax* command to program the *Focus Max* register with the *this* value (see the [Focus Control](#) section).

Focus	
NearFull	Execute
FarFull	Execute
FocusStepValue	255
NearStep	Execute
FarStep	Execute
FocusReqPosition	0
SetFocusPosition	Execute
FocusMax	0
FocusSetMax	Execute
FocusEncoderStatus	10000
GetFocusEncoderStatus	Execute
ResetFocusEncoder	Execute

Parameter Name	Type	Value	Access	Description
NearFull	Command		WO	Drives the focus to the fully Near position.
FarFull	Command		WO	Drives the focus to the fully Far position.
FocusSetupValue	Integer	Min: 1 Max: 255	RW	Sets the focus step used with the <i>NearStep</i> and <i>FarStep</i> commands.
NearStep	Command		WO	Drives the focus to the Near direction by the amount defined in the <i>FocusStepValue</i> feature.
FarStep	Command		WO	Drives the focus in the Far direction by the amount defined in the <i>FocusStepValue</i> feature.
FocusReqPosition	Integer	Min: 0 Max: FocusMaxReg	RW	Enter focus encoder value for best focus. Return to this position using the <i>SetFocusPosition</i> command.
SetFocusPosition	Command		WO	Drives the focus to the absolute position defined in the <i>FocusReqPosition</i> feature.
FocusMax	Integer		RO	Returns maximum focus encoder value.

Parameter Name	Type	Value	Access	Description
FocusSetMax	Command		WO	Sets the Focus Max Register with current <i>FocusMax</i> value.
FocusEncoderStatus	Integer		RO	Returns the current focus encoder value after the <i>GetFocusEncoderStatus</i> command is issued.
GetFocusEncoderStatus	Command		WO	Requests the focus encoder position value.
ResetFocusEncoder	Command		WO	Resets the Focus encoder.

Iris Category

Iris	
IrisRequestedPositionRaw	22
SetIrisPosition	Execute
CurrentFNumber	1.83401
OpenIrisFull	Execute
CloselIrisStep	Execute
OpenIrisStep	Execute
IrisStepValue	1
GetIrisRange	Execute
IrisMin	22
IrisMax	80
IrisRange	0x50161616

Parameter Name	Type	Value	Access	Description
IrisRequestedPositionRaw	Integer	Min: IrisMin2 Max: IrisMax	RW	Sets raw iris absolute position.
SetIrisPosition	Command		WO	Drives the iris to the absolute position value of <i>IrisRequestedPositionRaw</i> .
CurrentFNumber	Float		RO	Returns the current f-number value of the lens iris. Value of 0.0 signals an unknown iris position.
OpenIrisFull	Command		WO	Opens the iris to the fully opened position.
CloselIrisStep	Command		WO	Closes the iris by the amount defined in the <i>IrisStepValue</i> feature.
OpenIrisStep	Command		WO	Opens the iris by the amount defined in the <i>IrisStepValue</i> feature.
IrisStepValue	Integer	Min: 1 Max: 127	RW	Sets the iris step to be used with <i>OpenStep</i> and <i>CloseStep</i> commands.

Parameter Name	Type	Value	Access	Description
GetIrisRange	Command		WO	Sends the <i>Get Iris Range</i> command to the camera.
IrisMin	Integer		RO	Returns the minimum iris limit.
IrisMax	Integer		RO	Returns the maximum iris limit.
IrisRange	Integer		RO	Displays the limit values of the iris, after the <i>GetIrisRange</i> command is issued.

Transport Layer Control Category

The Transport Layer Control provides a variety of configuration settings and read-only information for configuring communications between the camera with the CoaXPress interface.

TransportLayerControl	
DeviceTapGeometry	Geometry_1X_1Y
CoaXPress	
Image1StreamID	1
ConnectionReset	Execute
DeviceConnectionID	0
MasterHostConnectionID	65792
ControlPacketSizeMax	4
StreamPacketSizeMax	8192
CxpLinkConfigurationPreferred	CXP6_X2
Cxp Link Configuration	CXP6_X2
TestMode	<input type="checkbox"/> False
TestErrorCount	0
TestPacketCountTx	0
TestPacketCountRx	0
CoaXPressCustomization	
Custom Cxp Link Configuration	CXP6_X2

Parameter Name	Type	Value	Access	Description
DeviceTapGeometry	Enumeration	String Geometry_1X_1Y	Num. RO 0	Describes the geometrical properties characterizing the taps of a camera as presented at the output of the device.

CoaXPress Category

Parameter Name	Type	Value	Access	Description
Image1StreamID	Integer		RO	Returns the STREAM ID for the primary image stream from the camera.
ConnectionReset	Command		WO	Activates the Link Reset procedure.
DeviceConnectionID	Integer		RO	Returns the ID of the camera's link.
MasterHostConnectionID	Integer		RO	Returns the Host link ID connected to this camera's master link.
ControlPacketSizeMax	Integer		RO	Returns the maximum control packet data size that the device can accept.

Parameter Name	Type	Value	Access	Description
StreamPacketSizeMax	Integer		RO	Returns the maximum stream packet data size that the host can accept.
CxpLinkConfiguration Preferred	Enumeration	String CXP1_X1 CXP2_X1 CXP3_X1 CXP5_X1 CXP6_X1 CXP1_X2 CXP2_X2 CXP3_X2 CXP5_X2 CXP6_X2	Num. 0x00010028 0x00010030 0x00010038 0x00010040 0x00010048 0x00020028 0x00020030 0x00020038 0x00020040 0x00020048	RO Provides the Link configuration that allows the Transmitter Device to operate in its default mode.
CxpLinkConfiguration	Enumeration	String CXP1_X1 CXP2_X1 CXP3_X1 CXP5_X1 CXP6_X1 CXP1_X2 CXP2_X2 CXP3_X2 CXP5_X2 CXP6_X2	Num. 0x00010028 0x00010030 0x00010038 0x00010040 0x00010048 0x00020028 0x00020030 0x00020038 0x00020040 0x00020048	RW Allows specifying the Link configuration for the communication between the Receiver and Transmitter Device. In most cases this feature does not need to be written because automatic discovery will set configuration correctly to the value returned by <i>CxpLinkConfigurationPreferred</i> .
TestMode	Boolean		RW	Enables the camera to send CXP link test packets to the host.
TestErrorCount	Integer		RW	Returns the current error count for a Host to Device link test. Writing a 0x0 clears the error counter.
TestPacketCountTx	Integer		RW	Returns the current transmitted connection test packet count. Writing a 0x0 clears the packet counter.
TestPacketCountRx	Integer		RW	Returns the current received connection test packet count. Writing a 0x0 clears the packet counter.

CoaXPress Customization Category

Parameter Name	Type	Value	Access	Description	
<i>CustomCxpLinkConfiguration</i>	Enumeration	String	Num.	RW	Allows the user to change the CXP link configuration from the Factory configuration (Dual CXP-6). After changing this parameter, use the UserSetControl to save the parameter to FLASH device. Changes take effect after the power cycle.
		CXP1_X1	0x00010028		
		CXP2_X1	0x00010030		
		CXP3_X1	0x00010038		
		CXP5_X1	0x00010040		
		CXP6_X1	0x00010048		
		CXP1_X2	0x00020028		
		CXP2_X2	0x00020030		
		CXP3_X2	0x00020038		
CXP5_X2	0x00020040				
CXP6_X2	0x00020048				

User Set Control Category

User Set Control allows you to save custom settings and reload them into the camera as needed.

▼ UserSetControl	
▼ UserSetSelector	Default
UserSetLoad	Execute
UserSetSave	Execute
UserSetDefault	Default

Parameter Name	Type	Value	Access	Description	
<i>UserSetSelector</i>	Enumeration	String	Num.	RW	Selects User Set to load, save, or configure. Default settings are configured by the factory and are write-protected
		Default	0		
		UserSet0	1		
		UserSet1	2		
		UserSet2	3		
UserSet3	4				
<i>UserSetLoad</i>	Command		WO	Loads User Set specified by <i>UserSetSelector</i> from non-volatile memory into camera RAM and makes it active.	
<i>UserSetSave</i>	Command		WO	Saves User Set 0, 1, 2 or 3 specified by <i>UserSetSelector</i> to non-volatile memory.	
<i>UserSetDefault</i>	Enumeration	String	Num.	RW	Selects User Set to load and activate when a camera is powered on or reset. Default Configuration is set by the factory.
		Default	0		
		UserSet0	1		
		UserSet1	2		
		UserSet2	3		
UserSet3	4				

Special Features Category

The Special Features parameters provide status information on the camera and on GenICam transport layer streaming.

SpecialFeatures	
DeviceStreaming	0
ParamsLocked	0

Parameter Name	Type	Value	Access	Description
DeviceStreaming	Integer		RO	Returns the state of the Camera streaming interface: 1 when grabbing, 0 when not.
ParamsLocked	Integer		RO	Returns the state of the GenTL or Camera streaming interface: 1 when grabbing, 0 when not.

Camera Features

Image Data Flow

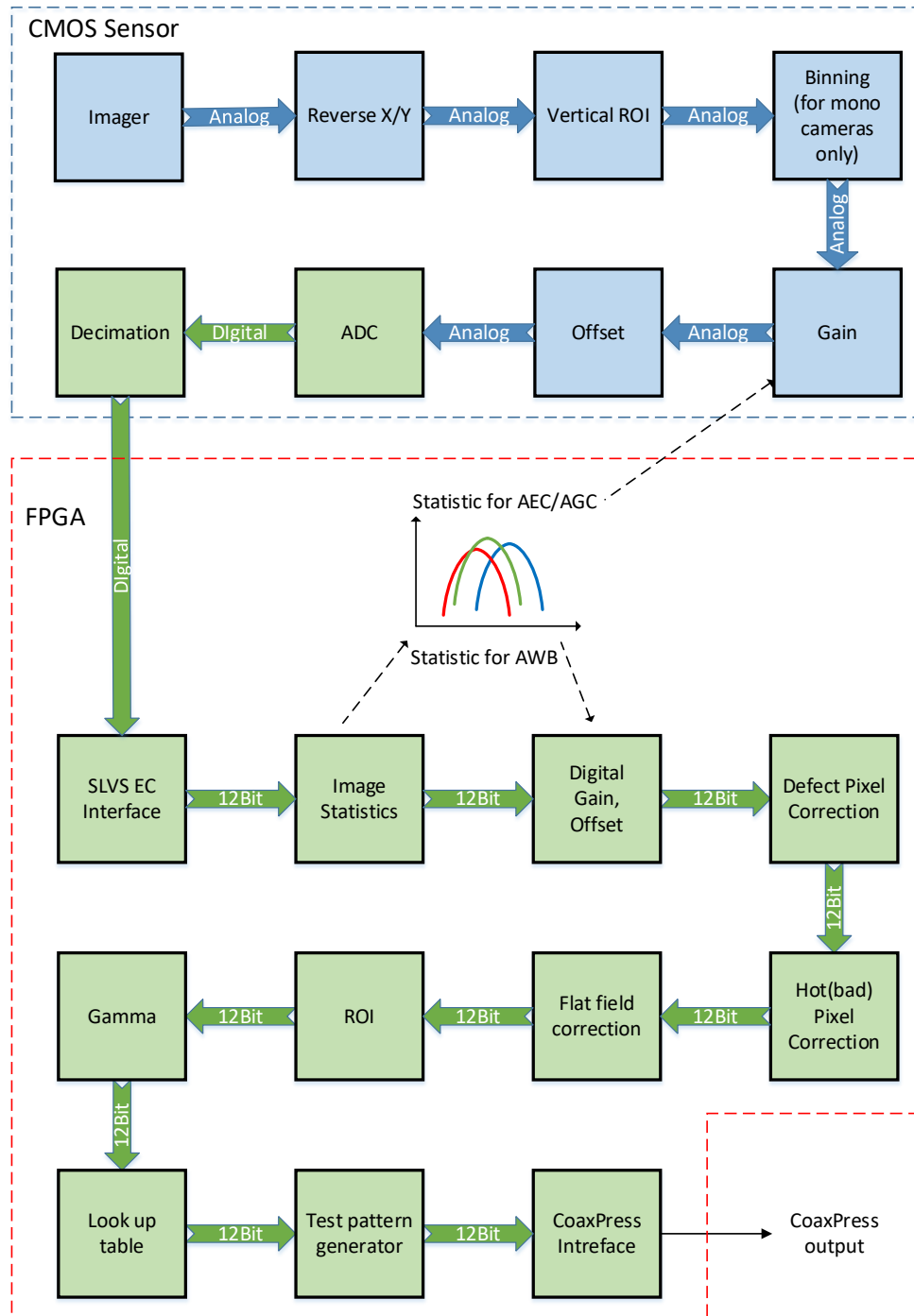

Exposure Control

The camera provides three exposure control modes – **Off**, **Timed**, and **Trigger Width**.

In the **Timed** mode, you can control exposure time manually or automatically. To enable manual control, set *ExposureAuto* to Off and specify the exposure time using the *ExposureTime* setting.

To enable AEC (Automatic Exposure Control), set *ExposureAuto* to Once or Continuous. Please refer to the section [Automatic Exposure and Gain Control](#) for more information on AEC.

The camera works either in trigger (Standard or Fast Trigger) or free-running (untriggered) mode, you might need to also adjust trigger parameters when setting exposure (refer to the section [Camera Triggering](#) for more information on trigger parameters).

NOTE (★) The AEC is not available when exposure mode is set to **Trigger Width**.

Exposure Control in Free-Running Mode

In **free-running mode**, the camera constantly reads out the sensor, and the exposure time is determined by the frame readout time. The exposure time equals the frame read out time when the exposure mode is set to **Off**.

Free-running mode, Exposure control is Off

Settings:

Exposure Mode: **Off**

Trigger Mode: **Off**

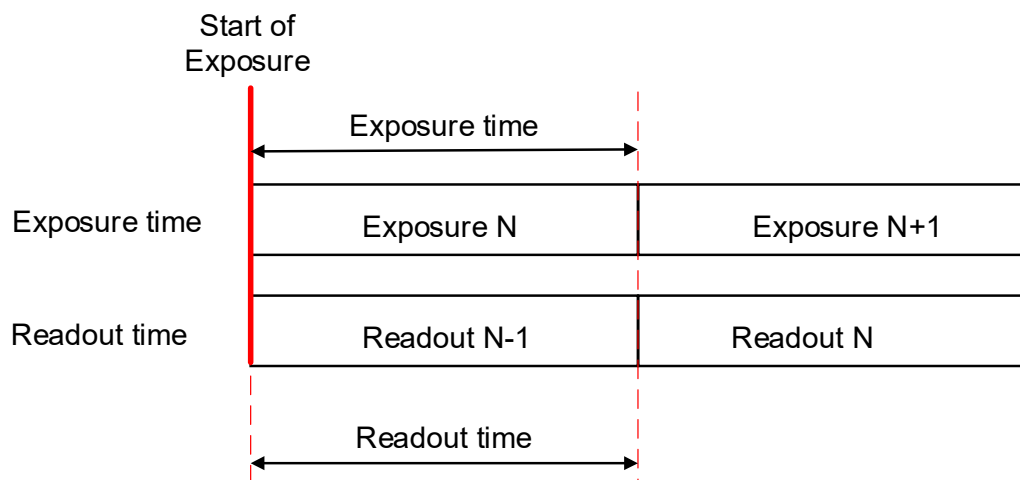

To reduce the image exposure time under bright lighting conditions, set the exposure control mode to **Timed**. The electronic exposure control does not affect the frame rate; it only changes the exposure time. When the Timed mode is active, the camera controls the start of exposure, so the new exposure ends just as the readout of the current frame ends and the readout of the next frame begins.

Free-running mode, Exposure control is Timed

Settings:

Exposure Mode: **Timed**

Trigger Mode: **Off**

Exposure Time: **User-specified** (Min.= 36 μ s; Max = Readout time)

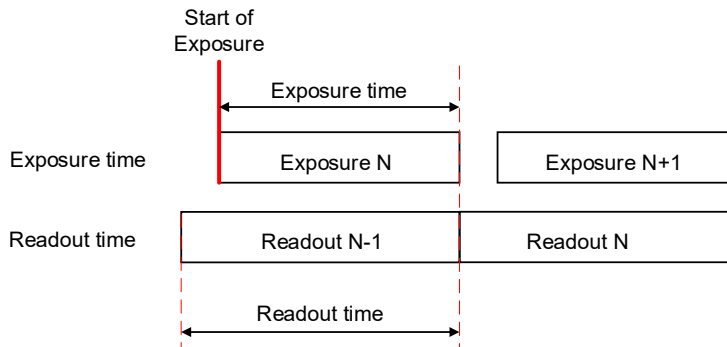

To configure the camera to work in free-running mode with Timed expose control:

1. Turn off the camera image acquisition.
2. Set *ExposureAuto* to **Off** for manual exposure control, or to either **Once** or **Continuous** for automatic exposure control.
3. In the Acquisition Control menu:
 - Set *TriggerMode* to **Off**.
 - Set *ExposureMode* to **Timed**.
 - If *ExposureAuto* is **Off**, then set *ExposureTime* (in microseconds) to a user-specified value.

NOTE *

In free-running mode, the maximum exposure time equals frame time. You can extend the exposure time by increasing the frame time:

1. Check *AcquisitionFrameRateEnable* box.
2. Increase the frame time by using *AcquisitionFrameTime* (in μ s) or *AcquisitionFrameRate* (in Hz) settings.
3. Set *ExposureTime* within the extended frame time range.

In free-running mode, the minimum exposure is 36 μ s.

While the *ExposureTime* allows for 1- μ s increments, the *CurrentExposureTime* increment equals 1-line time in μ s.

Exposure Control in Trigger Mode

In **trigger mode**, you can synchronize the camera's acquisition cycle to an external signal by setting the exposure control to either Timed or Trigger Width. Trigger mode can be set to either Standard or Fast (see [Camera Triggering](#)).

NOTE (★) The electronic exposure control does not affect the camera's frame rate in Fast trigger mode, because the exposure and readout operations are overlapped in time.

In Standard trigger mode, the maximum frame rate depends upon the exposure time, because the exposure and readout occur sequentially (not overlapped).

In **Timed** exposure control mode, the external trigger pulse controls the start of exposure. The exposure duration can be controlled manually or automatically (AEC).

To configure the camera to work in **Timed** exposure mode:

1. Turn off the camera image acquisition.
2. Set *ExposureAuto* to **Off** for manual exposure control, or to either **Once** or **Continuous** for automatic exposure control.
3. In the Acquisition Control menu:
 - Set *TriggerMode* to **On**.
 - Set *ExposureMode* to **Timed**.
 - If *ExposureAuto* is **Off**, then set *ExposureTime* (in μs) to a user-specified value.

NOTE (★) While the *ExposureTime* allows for 1- μs increments, the *CurrentExposureTime* increment equals 1-line time in μs . The camera rounds the *ExposureTime* up or down so that it is a multiple of the line-time (in μs)

4. Configure the trigger parameters.
Please refer to the section [Configuring the Trigger](#), steps 3–6.

In **Trigger Width** mode, the external trigger signal controls the start and duration of the exposure. This mode is available in both Standard and Fast trigger.

To configure the camera to work in **Trigger Width** exposure mode:

1. Turn off the camera image acquisition.
2. Make sure that *ExposureAuto* is **Off** and *AcquisitionFrameRateEnable* is unchecked.
3. In the Acquisition Control menu:
 - Set *TriggerMode* to **On**.
 - Set *ExposureMode* to **TriggerWidth**.
4. Configure the trigger pulse parameters.
Please refer to the section [Configuring the Trigger](#), steps 3–6.

NOTE (*) In Standard Trigger mode, the maximum exposure time is defined by the formula:

$$\text{Exposure Time (max)} = \text{Trigger Period} - \text{Readout Time},$$

where the Readout Time is equal to the *CurrentFrameTime* (in free-running mode, with *AcquisitionFrameRateEnable* off).

In **Standard** trigger mode, the minimum exposure is equal to 1 line time. This value depends on a sensor model and some other parameters such as *PixelFormat*.

In **Fast** trigger mode, the maximum exposure time is 16 s, and the minimum exposure time is 36 microseconds.

Global Shutter

In global shutter mode, all pixels in the array reset at the same time, then collect signal during the exposure time, and finally transfer the image to a pixel memory region within each pixel. After transferring the image to the pixel memory region, the readout of the array begins. In this way, all pixels capture the image during the same period, which reduces any image artifacts due to motion within the scene. The maximum exposure is frame-time dependent, and the minimum exposure varies based on the image sensor.

The camera overlaps the exposure and read-out times in free-running and Fast Trigger modes as shown in the following figure.

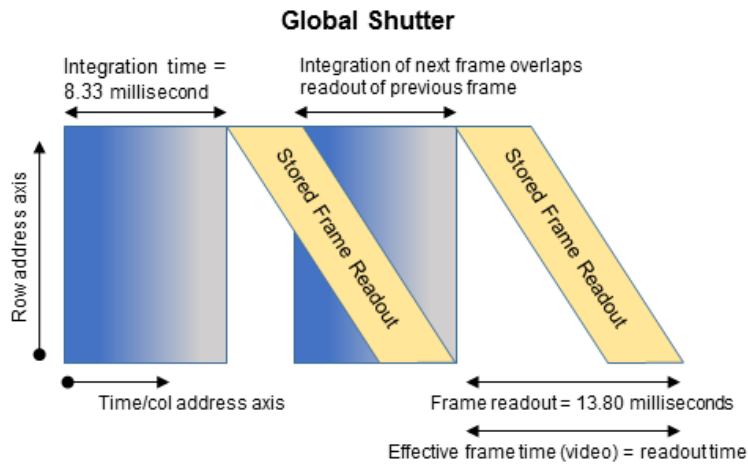

Automatic Exposure and Gain Control

Automatic exposure control (AEC) and automatic gain control (AGC) enable the camera to maintain the same image brightness during the changing lighting conditions. You can enable both AEC and AGC independently or together by setting *ExposureAuto* and *GainAuto* to either **Once** or **Continuous**.

AEC/AGC Mode	Description
Off	AEC/AGC is disabled and a manual control is on. The camera applies the exposure time and gain you enter using the <i>ExposureTime</i> and <i>Gain</i> controls.
Once	Exposure duration/gain is adapted once by the camera. Once it has converged, it returns to the Off state; and the exposure and gains determined during the Once process are maintained until changed manually.
Continuous	Exposure duration/gain is constantly adapted by the camera to maximize the dynamic range.

When AEC / AGC are in **Continuous** or **Once** mode, you can set the image luminance (brightness) target (*ExposureGainAutoTarget*), and the camera adjusts the exposure and/or gain accordingly. The luminance target is a 12-bit value (4095 is a max. value). To determine the luminance target when using 8-bits per pixel, take the desired output in ADUs and multiply this value by 16. The target luminance is the average luminance within the image.

Also, for the **Once** mode, you can set an acceptable difference between the target and current image luminance (*ExposureGainAutoTargetThreshold*) in the range from 0 to 4095. When the threshold is reached, the camera turns off AEC/AGC algorithms and enables manual control over exposure duration and/or gain.

CAUTION

In some rapidly changing and bright light conditions, an image brightness oscillation (image intensity flipping from bright to dark) could occur. To prevent this, increase the AEC minimum exposure setting, increase the target luminance level and/or decrease the lens iris.

Initial conditions for AEC and AGC algorithms:

Exposure and gain are set to the user-specified values of the *ExposureTime* and *Gain* controls.

When AEC and AGC are enabled together, you might need to select whether to adjust gain or exposure first using *ExposureGainAutoPriority* control.

- If the **exposure priority** is selected (**ExposureTime**), the camera adjusts the exposure first within the user-specified minimum/maximum limits. If one of the limits is reached before the target image luminance (or threshold) is achieved, then gain is applied. The camera varies the gain until either the target image luminance (or threshold) is reached or one of gain limits is reached.
- If the **gain priority** is selected (**Gain**), the camera adjusts the gain first within the user-specified minimum/maximum limits. If one of the limits is reached before the target image

luminance (or threshold) is achieved, the exposure is applied. The camera varies the exposure until either the target image luminance (or threshold) is reached or one of exposure limits is reached.

By default, the *ExposureGainAutoPriority* control are set to **ExposureTime**.

The AEC and AGC algorithms sample all pixels for the entire frame. The camera displays the current luminance within the frame.

P, I, and D Coefficients

The P (Proportional), I (Integral), and D (Derivative) coefficients of PID feed-back control loops determine speed and stability of AEC and AGC algorithms.

A PID controller continuously calculates a difference (an error) between a setpoint (SP)—*ExposureGainAutoTarget*— and a process variable (PV)—*AverageLuminosity*. Based on the sum of proportional, integral, and derivative responses, the controller determines an output value and adjusts exposure or gain to minimize the error. The PID controller continuously varies the output value until the luminance reaches the setpoint.

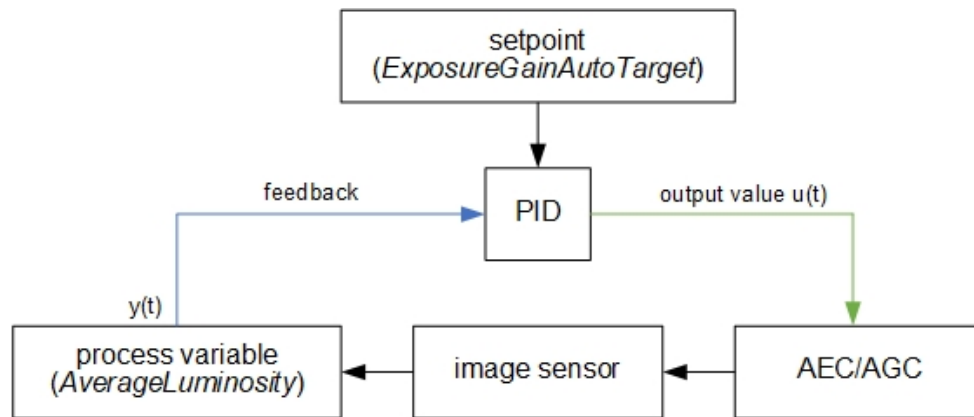

The AGC algorithm uses all three responses with a manual control available over the P, I, and D coefficients.

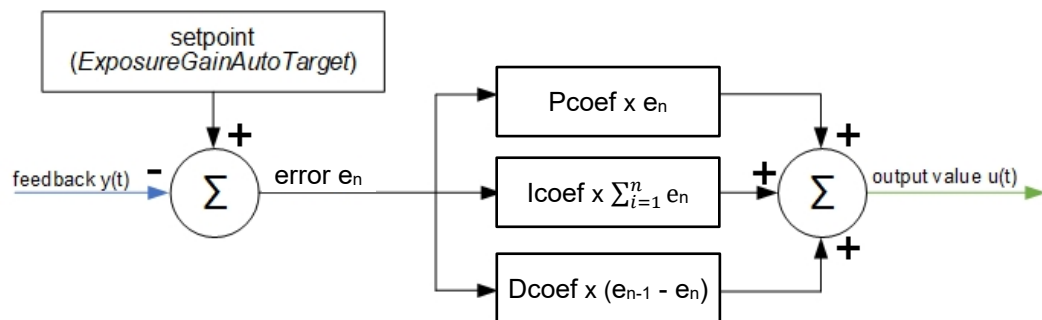

The AEC algorithm uses only two responses – proportional and derivative with a manual control available over the P coefficient only.

AEC/AGC	PID coefficients controls
AEC	P varies depending on exposure I = 0 D = P/2
AGC	P, I, and D are fixed values

Proportional Response

The proportional response is a difference (error) between the setpoint and the process variable. This error is then multiplied by the proportional coefficient P.

NOTE * Increasing the P coefficient increases the speed of the control algorithm and degrades its stability. If the P coefficient is too high, the image luminance begins to oscillate. With further increase of the P coefficient, the oscillations become larger, and the system becomes unstable and may even oscillate out of control.

The AEC algorithm uses an adaptive P coefficient.

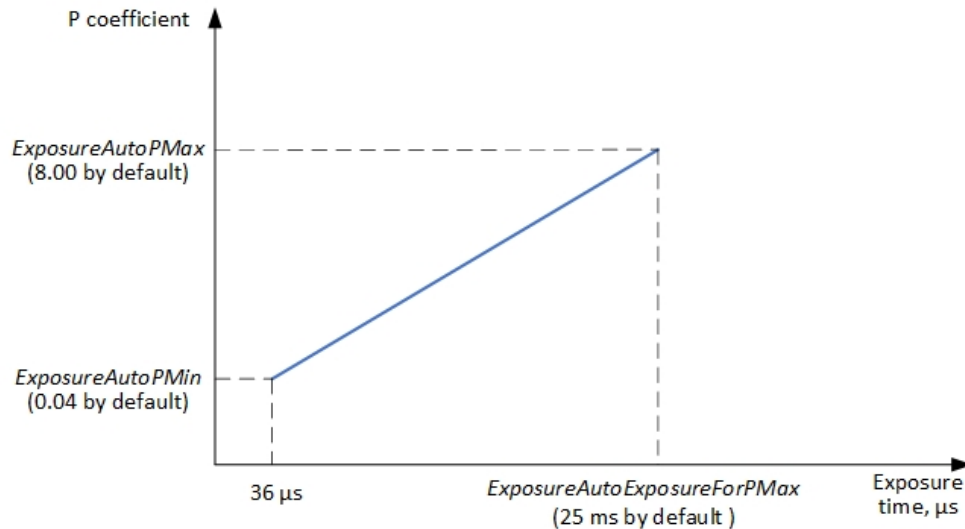

The PID controller applies the P coefficient calculated on the previous iteration, computes the error, and adjusts exposure. The controller then re-calculates the P coefficient and applies the new value in the next iteration.

Integral Response

The integral response is the sum of the calculated errors over time multiplied by the integral coefficient I.

NOTE * Increasing the I coefficient decreases the speed of the control algorithm and degrades its stability.

Derivative response

The derivative response is the difference between the error found on the previous sample and the current error multiplied by the derivative coefficient D. The derivative response is sensitive to noise in the process variable signal. use very small derivative time

NOTE * Increasing the D coefficient increases the speed of the control algorithm and improves its stability.

CAUTION

We do not recommend changing P, I, and D coefficients. Changing the coefficients may cause oscillations and destabilize the system.

If you need to change the coefficients, please contact Imperx support.

Imperx sets up optimal P, I, and D coefficients to balance the speed and stability of AEC and AGC algorithms.

XML Parameter	Default value
For AEC algorithm:	
ExposureAutoPMin	0.04
ExposureAutoPMax	8.00
ExposureAutoExposureForPMax	25,000 microseconds
For AGC algorithm:	
GainAutoPcoef	0.06
GainAutoIcoef	0.00
GainAutoDcoef	0.03

Camera Triggering

Use the **Trigger Mode** control to synchronize the camera to an external event and acquire an image at a specific time. A trigger pulse is issued when the external event occurs. The camera then receives the trigger and acquires the images.

You can set the number of frames to acquire for each trigger using *AcquisitionBurstFrameCount* control. By default, *AcquisitionBurstFrameCount* is equal to 1 frame. The maximum number of frames is 65535.

The camera supports Standard and Fast Trigger modes. For the camera to work in the Standard Trigger mode, set *TriggerOverlap* parameter to Off. For the camera to work in the Fast Trigger mode, set *TriggerOverlap* parameter to ReadOut.

Standard Trigger Mode

In **Standard Trigger mode**, the camera first performs the exposure and then reads out the image. An external timing pulse controls the start of the exposure if exposure control mode is set to **Timed**.

Standard trigger mode, Exposure control is Timed

GenICam controls

TriggerMode: **On**

TriggerOverlap: **Off**

TriggerSource: **Line 1** (or Line2, Software, Pulse Generator, Link Trigger)

TriggerActivation: **Rising Edge** (or Falling Edge)

TriggerFilterTime, TriggerDelay, TriggerDebounceTime: – **set if applicable**.

Exposure Mode: **Timed**

For manual exposure control:

Exposure Time: **User-specified** (Min. = 36 μ s; Max = Readout time)

ExposureAuto: **Off**

For automatic exposure control (AEC):

ExposureAuto: **Continuous** (or Once)

Parameters of the external trigger pulse

Trigger width: $\geq 10 \mu$ s

Trigger period (min) = Exposure time (max) + Readout time

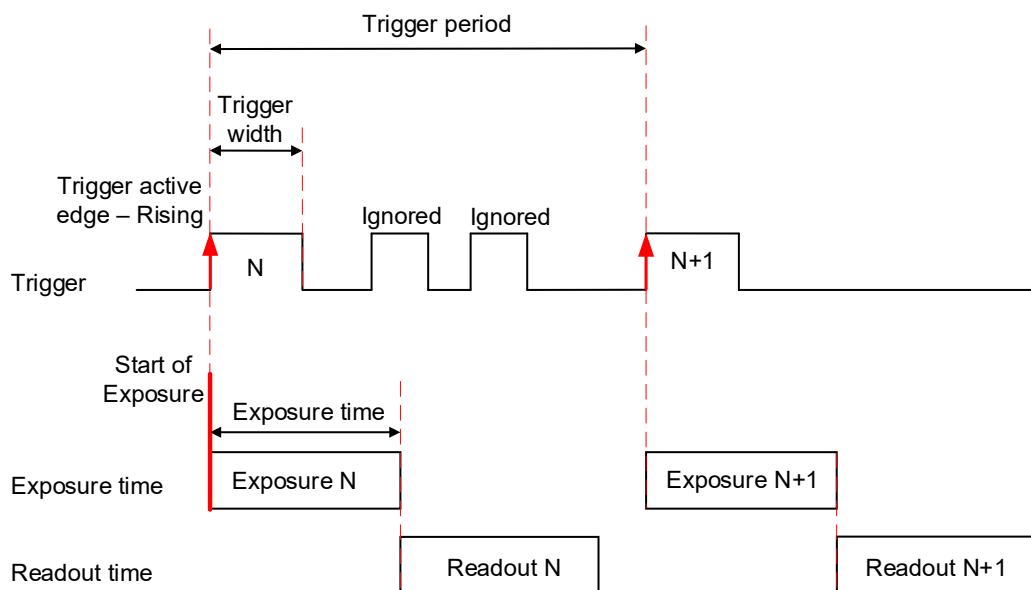

Setting exposure control mode to **Trigger Width** allows the external timing pulse to control the exposure duration.

Standard trigger mode, Exposure control is Trigger Width

GenICam controls

TriggerMode: **On**
 TriggerOverlap: **Off**
 TriggerSource: **Line 1** (or Line2, Pulse Generator, Link Trigger)
 TriggerActivation: **Rising Edge** (or Falling Edge)
 TriggerFilterTime, TriggerDelay, TriggerDebounceTime: **set if applicable**
 ExposureMode: **Trigger Width**

Parameters of the external trigger pulse

Trigger width: $\geq 10 \mu\text{s}$
 Trigger period (min) = Exposure time (max) + Readout time

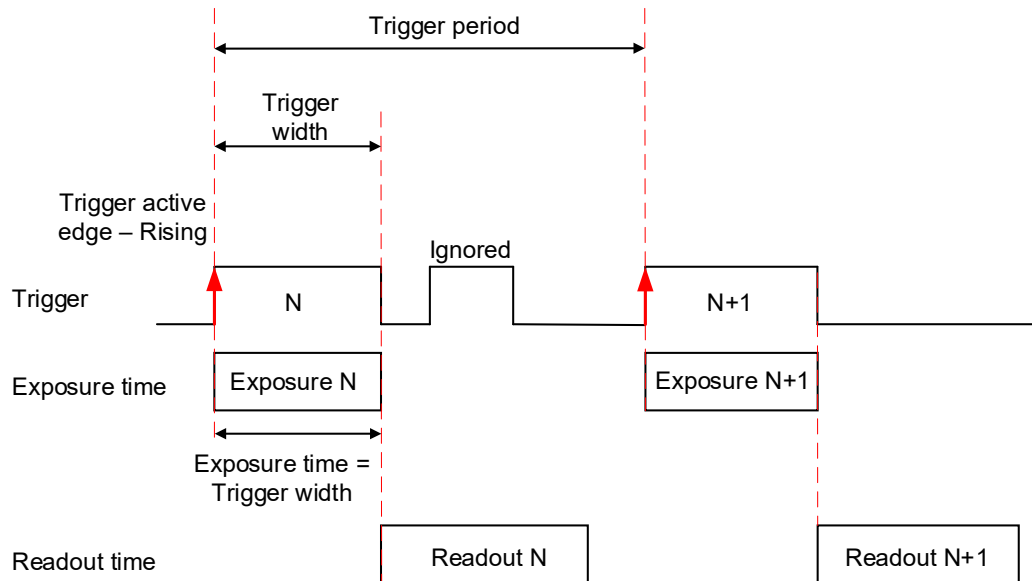

The minimum trigger period is equal to the maximum exposure time plus the camera readout time:

$$\text{Trigger Period (min)} = \text{Exposure Time (max)} + \text{Readout Time,}$$

where the Readout Time is equal to the *CurrentFrameTime* (in free-running mode, with *AcquisitionFrameRateEnable* disabled).

If the next trigger pulse appears during the previous trigger period, the camera ignores it.

Fast Trigger Mode

In **Fast Trigger mode**, the exposure and readout are overlapped in a way that is similar to free-running (untriggered mode). Fast trigger mode depends upon a constant and stable trigger source so the camera can position the exposure period to conclude just as the previous frame readout ends. If the trigger period varies, the exposure varies with the trigger period, and uneven image illumination or wavering image brightness results.

An external timing pulse controls the start of the exposure when exposure control mode is **Timed**. The new exposure ends just as the readout of the current frame ends. The readout of the next frame begins with the next trigger. If the next trigger pulse appears during the previous trigger period, the camera ignores it.

Fast trigger mode, Exposure control is Timed

GenICam controls

Trigger Mode: **On**

Trigger Overlap: **On**

Trigger Source: **Line 1** (or Line2, Pulse Generator, Link Trigger)

Trigger Activation: **Falling Edge** (or Rising Edge)

TriggerFilterTime, TriggerDelay, TriggerDebounceTime: – **set if applicable**

Exposure Mode: **Timed**

Exposure Time: **User-specified** (Min. = 36 μ s; Max = Readout time)

Parameters of the external trigger pulse:

Trigger width: $\geq 10 \mu$ s

Trigger period (min) = Readout time

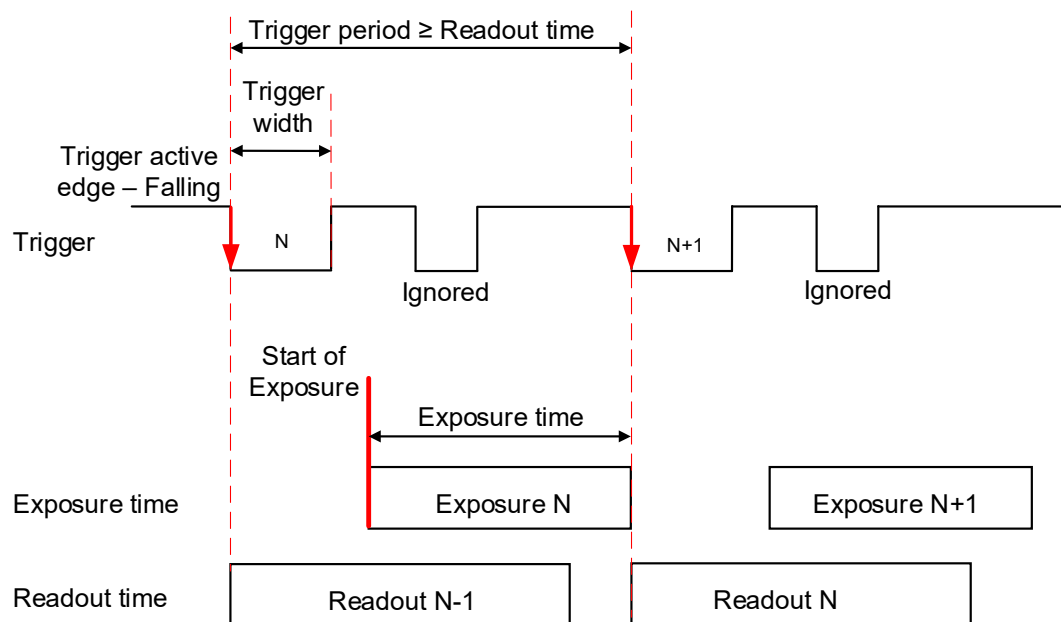

An external timing pulse controls the start and duration of exposure when *ExposureMode* is set to **Trigger Width**. The new exposure begins with the next trigger pulse during the readout of the current frame.

For trigger signal with a constant period, set the *TriggerActivation* parameter to either **Falling** or **Rising Edge**. If using a trigger signal with varying period, set the *TriggerActivation* parameter to **Falling Edge**.

Fast trigger mode, Exposure control is Trigger Width

GenICam controls

TriggerMode: **On**

TriggerOverlap: **On**

TriggerSource: **Line 1** (or Line2, Pulse Generator, Link Trigger)

TriggerActivation: **Falling Edge** (or Rising Edge)

TriggerFilterTime, TriggerDelay, TriggerDebounceTime: **set if applicable**

ExposureMode: **Trigger Width**

Parameters of the external trigger pulse

Trigger width: $\geq 10 \mu\text{s}$

Trigger period: \geq Readout time

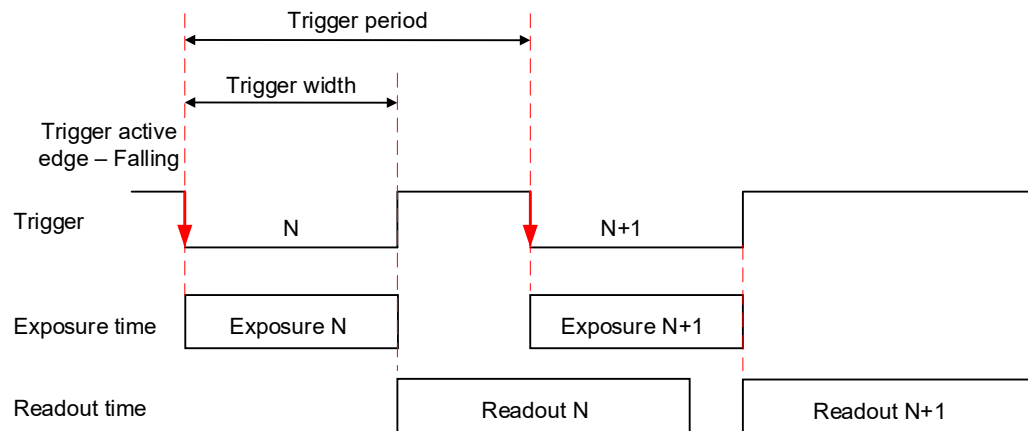

Trigger Sources

The camera allows for five sources for triggering: external Line1 or Line2, internal (pulse generator), trigger over CXP link, and software. The minimum trigger pulse is 10 microseconds.

- **Line 1** – hardware Input Line GP Input1 (Trigger 1) is used as external source for the trigger signal.
- **Line 2** – hardware Input Line GP Input2 (Trigger 2) is used as external source for the trigger signal.
- **LinkTrigger** – CXP Link Trigger is used as source for the trigger signal. A frame grabber should be configured to generate a trigger pulse.
- **Pulse Generator** – trigger source is generated by camera's internal Pulse Generator.
- **Software** – the camera expects a computer to send a command to the camera for generating one short trigger pulse. You can trigger the camera by clicking the GUI Software Trigger button or by sending the GenICam Trigger Software command.

Configuring the Trigger

To configure the camera to work in **trigger mode**, follow the steps below:

1. Turn off the camera image acquisition.
2. In the Acquisition Control menu, set *TriggerMode* to **On**.
3. Set *TriggerOverlap* to either **Readout** for the camera to work in Fast Trigger mode or to **Off** for the camera to work in Standard Trigger mode.
4. Select *TriggerSource*:
 - If *TriggerSource* is either Line1 (Input1) or Line2 (Input2), configure the external trigger signal source using *LineInverter* feature.
 - If *TriggerSource* is LinkTrigger, configure your frame grabber to generate trigger pulses.
 - If *TriggerSource* is PulseGenerator, configure the camera's internal pulse generator (see section Pulse Generator) and make sure that the *PulseGenEnable* setting is checked.
 - If *TriggerSource* is Software, you do not need to configure a signal source. The camera generates one short trigger pulse when you click the GUI Software Trigger button or send the GenICam™ Trigger Software command.
5. For *TriggerActivation* setting, select what edge (**Rising** or **Falling**) will be used for triggering.

NOTE *

If the *TriggerActivation* is RisingEdge and *ExposureMode* is set to **TriggerWidth**, the exposure duration will be the time the trigger stays high.

If *TriggerActivation* is FallingEdge and the *ExposureMode* is set to **TriggerWidth**, the exposure time will last as long as the trigger stays low.

Set *TriggerActivation* to **FallingEdge** if the camera works in Fast trigger mode (*TriggerOverlap* is set to **Readout**) with a varying trigger period.

6. If applicable, set *TriggerFilterTime*, *TriggerDebounceTime*, *TriggerDelay* to desired values. The *TriggerFilterTime* and *TriggerDebounce* features are used to prevent false triggering when a trigger signal is being generated by an external source mapped to the camera's Input 1 or Input 2.

TriggerFilterTime

Defines the input trigger signals minimum pulse width. By setting the *TriggerFilterTime* to a value slightly less than the input signal's pulse width, the camera will reject any noise with pulse widths less than the *TriggerFilterTime* setting

<i>TriggerDebounce</i>	Defines the time period following a triggering event in which no additional triggers will be accepted by the camera. . Always set the <i>TriggerDebounceTime</i> to a value higher than the trigger signal's pulse width. The camera filters out interfering signals once the trigger pulse ends. The camera ignores any pulses during the <i>TriggerDebounceTime</i> after receiving the trigger signal.
<i>TriggerDelay</i>	Defines the time between the beginning of the trigger pulse and the beginning of the exposure. The camera captures an image with some delay after the trigger event

Trigger pulse width: $\geq 10 \mu\text{s}$
TriggerFilterTime: Recommended value $\leq 75\%$ of the Trigger pulse width
 Max. *TriggerFilterTime* = 65535 μs
 Max. *TriggerDebounceTime* = 65535 μs
 Max. *TriggerDelay* = 16000000 μs

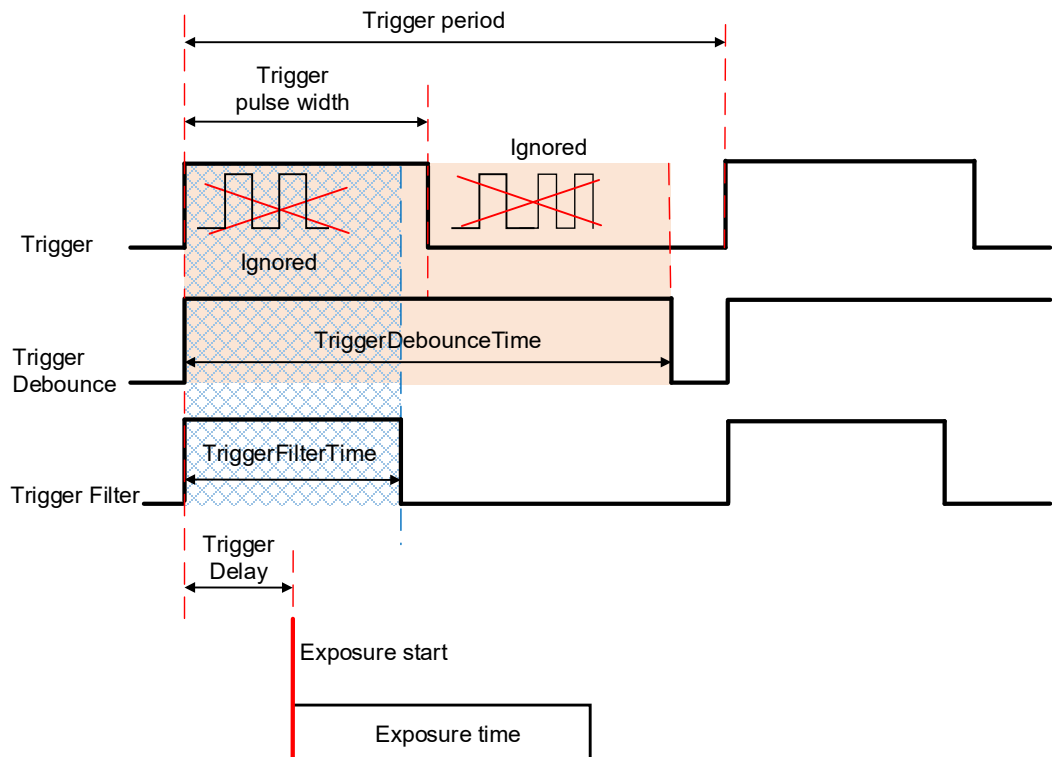

Video Amplifier Gain and Offset

Image Sensor's Analog and Digital Gain

The image sensor allows you to apply up to 48 dB of gain to the image prior to A/D conversion. The first 24 dB of gain is analog gain and some improvement in noise performance may result. The camera applies the last 24 dB of gain digitally, which affects both signal and noise equally.

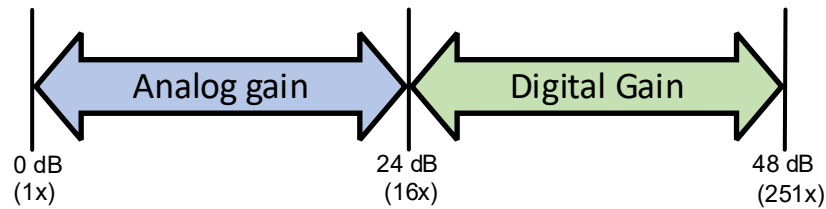

Digital Gain

Digital gain can be varied from 1x (0 dB) to 4x (12 dB) with a precision of $\sim 0.00097x$ using the raw (fine) gain control. There are 3,092 gain steps from 1x gain to 4x gain. Each step increases the gain by 0.001. Digital Gain does not provide any improved contrast and should be used cautiously.

Black Level Auto-Calibration and Offset

The camera automatically adjusts black level based on measurements of the dark reference lines at the start of each frame. Imperx recommends leaving the *BlackLevelAuto* engaged (Continuous). If *SensorBlackLevelRecommended* is disabled (set to false), you can set the *BlackLevel* manually and adjust it from 0 to 4095 counts. Black level will vary with temperature and gain.

Data Output Format

The image sensor digitization is set automatically based on the *Pixel Format* setting. A *Pixel Format* of 8- or 10-bits enables 10-bits sensor digitization while *Pixel Format* of 12-bits sets sensor digitization to 12-bits.

With 8-bit output, the camera uses the standard bit reduction process and truncates the least significant bits as described below.

12-bits sensor digitization

If the camera is set to output 12-bit data, sensor data bits map directly to D0 (LSB) to D11 (MSB).

MSB		Camera Output – 12 bits								LSB	
D11	D10	D9	D8	D7	D6	D5	D4	D3	D2	D1	D0
P11	P10	P9	P8	P7	P6	P5	P4	P3	P2	P1	P0

10-bits sensor digitization

If the camera is set to output 10-bit data, sensor data bits map directly to D0 (LSB) to D9 (MSB).

MSB		Camera Output – 10 bits							LSB	
D9	D8	D7	D6	D5	D4	D3	D2	D1	D0	
P9	P8	P7	P6	P5	P4	P3	P2	P1	P0	

If the camera is set to output 8-bit data, sensor most significant data bits (P2 to P9) map to D0 (LSB) to D7 (MSB).

MSB		Camera Output – 8 bits							LSB	
D7	D6	D5	D4	D3	D2	D1	D0	-	-	
P9	P8	P7	P6	P5	P4	P3	P2	P1	P0	

Pulse Generator

The camera has a built-in pulse generator that you can program to generate a discrete sequence of pulses or a continuous sequence. You can use the pulse generator as a trigger signal or map it to one of the outputs. You can set the discrete number of pulses from 1 to 65535 with a step of 1 or configure the pulse generator to work in continuous mode.

You can also set the following options:

- **Granularity** – Indicates the number of clock cycles used for each increment of the width and the period. Four possible options are available: x1, x10, x100, and x 1000.
- **Width** – Specifies the amount of time (determined by the granularity) the pulse remains at a high level before falling to a low level.
- **Period** – Indicates the amount of time (also determined by the granularity) between consecutive pulses.

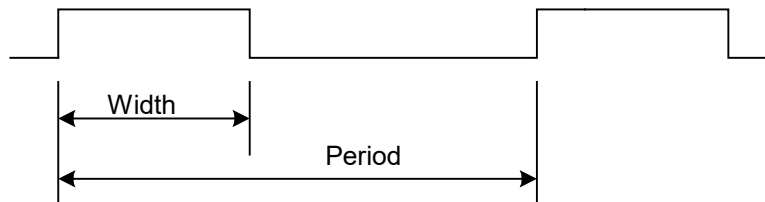

Input / Output Control

The camera supports two inputs and two outputs (TTL and opto-isolated):

Input / Output #	Pin #	Description	Voltage/Current
Input 1	Pin 8 and Pin10 (Return)	Opto-isolated	Voltage 3.3–24 V, Current (min) 3.3 mA
Input 2	Pin 9 and Pin 11 (Return)	TTL/LVTTL	Voltage 5 V (TTL) or 3.3 V (LVTTL) Current (max) 2.0 mA
Output 1	Pin 7 and Pin 6 (Return)	TTL	Voltage 5.0 V (TTL) Current (max) 8.0 mA
Output 2	Pin 12 and Pin 5 (Return)	Opto-isolated	Voltage (max) 25 V Current (max) 50 mA

You can map Input 1 or Input 2 to the camera trigger source by following the steps 1 – 6 in the section [Configuring the Trigger](#). In Step 4, set *TriggerSource* to **Line 1** (Input1) or **Line 2** (Input2) respectively.

You can invert the input signal by using *LineInverter* setting in the Digital IO Control menu:

1. Select Input1 or Input2 in *LineSelector*.
2. Check the *LineInverter* box.

You can map one of nine signals to either Output 1 or Output 2 in the Digital IO Control menu:

1. Set *LineSelector* to **Output1** or **Output2**.
2. Select output signal in *LineSource* menu (refer to the section [Strobe and Synchronization Controls](#)).
3. You can invert the output signal by checking the *LineInverter* box.
4. If applicable, enable a strobe and specify its width, delay, and reference (for more information, refer to the section [Configuring the Strobe in Free-Running Mode](#) or [Configuring a Strobe in Trigger Mode](#)).

Strobe and Synchronization Controls

The camera allows you to synchronize your system from several references. You can synchronize with the trigger input, the start, middle or end of exposure, or the internal pulse generator signals.

Output Signal	Description
ExposureStart	A 10-microsecond pulse indicating the beginning of the exposure
ExposureEnd	A 10-microsecond pulse indicating the end of the exposure
MidExposure	A 10-microsecond indicating the middle of the exposure
ExposureActive	The output signal is active for the duration of exposure time
TriggerActual	Maps the input trigger pulse to the output with no delay
TriggerDelayed	Maps the input trigger pulse to the output with trigger delay
PulseGenerator	Maps the internal pulse generator waveform to the output
Strobe1	Maps the Strobe 1 signal to the corresponding external output
Strobe2	Maps the Strobe 2 signal to the corresponding external output

The camera provides signals indicating the start of exposure, mid-exposure, and end of exposure. These signals have a fixed duration of 10 microseconds. If a longer pulse period is required, the strobe feature can be used.

The camera provides two strobes for synchronization with an external light source, other cameras, or peripheral devices. You can position each strobe pulse within the entire frame-timing period with a precision of 1.0 microsecond.

You can position a strobe pulse with the following references, depending on the camera mode:

Camera Mode	Strobe Reference
Free-running mode	Start of Exposure, Start of Readout
Trigger mode (Standard and Fast)	Start of Exposure, Start of Readout, Trigger

Configuring the Strobe in Free-Running Mode

In **free-running mode**, you can set the strobe pulse duration (*StrobeWidth*) and the delay (*StrobeDelay*) with respect to the start of the exposure or the start of the readout period. The strobe period is equal to the frame time. You can map a strobe to either Output 1 (TTL) or Output 2 (opto-isolated).

Positioning the Strobe1 with a Reference to the Exposure Start

1. In the DigitalIOControl menu, set *LineSelector* to Output1 (TTL) or Output2 (opto-isolated).
2. Set *LineSource* to Strobe1.
The strobe is mapped to the output selected under *LineSelector*.
3. If necessary, check the *LineInverter* box.
It inverts the output signal.
4. Set *Strobe1Reference* to Start of Exposure.
5. Set *Strobe1Enable* to On.
6. If necessary, set *Strobe1Delay*.
Without a delay, the strobe occurs simultaneously with the start of exposure.
7. Set *Strobe1Width* to a desired value.

Positioning the Strobe2 with a Reference to the Readout Start

1. In the DigitalIOControl menu, set *LineSelector* to Output1 (TTL) or Output2 (opto-isolated).
2. Set *LineSource* to Strobe2.
The strobe is mapped to the output selected under *LineSelector*.
3. If necessary, check the *LineInverter* box.
It inverts the output signal.
4. Set *Strobe2Reference* to Start of Readout.
5. Set *Strobe2Enable* to On.
6. If necessary, set *Strobe2Delay*.
Without a delay, the strobe occurs simultaneously with the start of exposure.
7. Set *Strobe2Width* to a desired value.

Strobes Positioned with Respect to the Start of Exposure and Readout, Free-running Mode

GenICam controls

TriggerMode: **Off**

LineSelector: **Output1** (or Output2)

LineSource: **Strobe1** (or Strobe2)

Strobe1Reference: **Start of Exposure**

Strobe1Enable: **On**

Strobe1Width: **User-specified** (Min.= 10 μ s)

Strobe1Delay: **User-specified** (in μ s)

Strobe2Reference: **Start of Readout**

Strobe2Enable: **On**

Strobe2Width: **User-specified** (Min.= 10 μ s)

Strobe2Delay: **User-specified** (in μ s)

Exposure Mode: **Timed** (or Off)

For manual exposure control:

Exposure Time: **User-specified** (Min.= 36 μ s; Max = Readout time)

ExposureAuto: **Off**

For automatic exposure control (AEC):

ExposureAuto: **Continuous** (or Once)

Parameters of the strobe signal

Strobe period = frame time

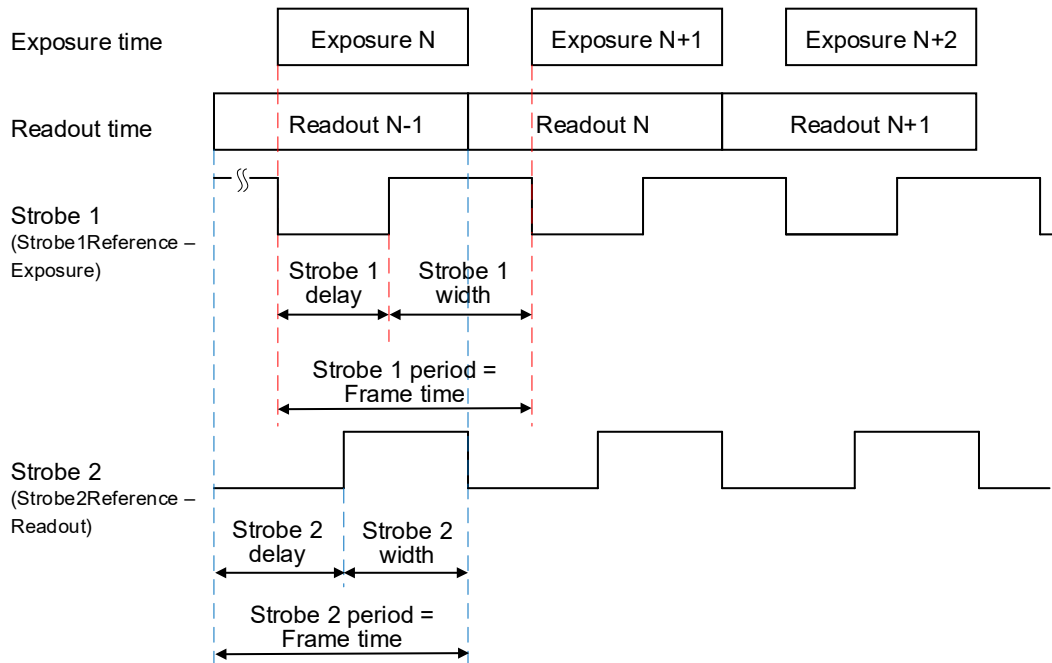

Configuring a Strobe in Trigger Mode

If the camera is in the **Trigger mode** (Standard or Fast Trigger), you can set the strobe pulse duration and the delay with respect to the trigger pulse active edge, start of the exposure, or start of the readout period. The strobe period equals the trigger period.

Positioning the Strobe1 with a Reference to Trigger or Exposure Start

1. Make sure that *TriggerMode* is On in the Acquisition Control menu.
2. Select a *TriggerSource* and *TriggerActivation*.
3. Set *TriggerDelay* to 0. If applicable, set *TriggerFilterTime* and *TriggerDebounce* to desired values.
4. In the DigitalIOControl menu, set *LineSelector* to Output1 (TTL) or Output2 (opto-isolated).
5. Set *LineSource* to Strobe1.
The strobe is mapped to the output selected under *LineSelector*.
6. If necessary, check the *LineInverter* box.
It inverts the output signal.
7. Set *Strobe1Reference* to Trigger (or Start of Exposure).
8. Set *Strobe1Enable* to On.
9. If necessary, set *Strobe1Delay*.
Without a delay, the strobe occurs simultaneously with the trigger active edge (start of exposure).
10. Set *Strobe1Width* to a desired value.

Positioning the Strobe2 with a Reference to the Readout Start

1. Make sure that *TriggerMode* is On in the Acquisition Control menu.
2. Select a *TriggerSource* and *TriggerActivation*.
3. If applicable, set *TriggerDelay*, *TriggerFilterTime* and *TriggerDebounce* to desired values.
4. In the DigitalIOControl menu, set *LineSelector* to Output1 (TTL) or Output2 (opto-isolated).
5. Set *LineSource* to Strobe2.
The strobe is mapped to the output selected under *LineSelector*.
6. If necessary, check the *LineInverter* box.
It inverts the output signal.
7. Set *Strobe2Reference* to Start of Readout.
8. Set *Strobe2Enable* to On.

9. If necessary, set *Strobe2Delay*.
Without a delay, the strobe occurs simultaneously with the start of exposure.
10. Set *Strobe2Width* to a desired value.

Strobes Positioned with Respect to a Trigger, Exposure Start, or Readout Start
Standard Trigger Mode

GenICam controls

TriggerMode: **On**
 TriggerOverlap: **Off**
 TriggerSource: **Line 1** (or Line2, Pulse Generator, Link Trigger)
 TriggerActivation: **Rising Edge** (or Falling Edge)
 TriggerDelay: **0** (no delay)
 TriggerFilterTime, TriggerDebounceTime: **set if applicable**

LineSelector: **Output1** (or Output2)
 LineSource: **Strobe1** (or Strobe2)
 Strobe1Reference: **Trigger** (or Start of Exposure)
 Strobe1Enable: **On**
 Strobe1Width: **User-specified** (Min. = 10 μ s)
 Strobe1Delay: **User-specified** (in μ s)
 Strobe2Reference: **Start of Readout**
 Strobe2Enable: **On**
 Strobe2Width: **User-specified** (Min. = 10 μ s)
 Strobe2Delay: **User-specified** (in μ s)

Exposure Mode: **Timed**

For manual exposure control:

Exposure Time: **User-specified** (Min. = 36 μ s; Max = Readout time)

ExposureAuto: **Off**

For automatic exposure control (AEC):

ExposureAuto: **Continuous** (or Once)

Parameters of the strobe signal

Strobe period = Trigger period

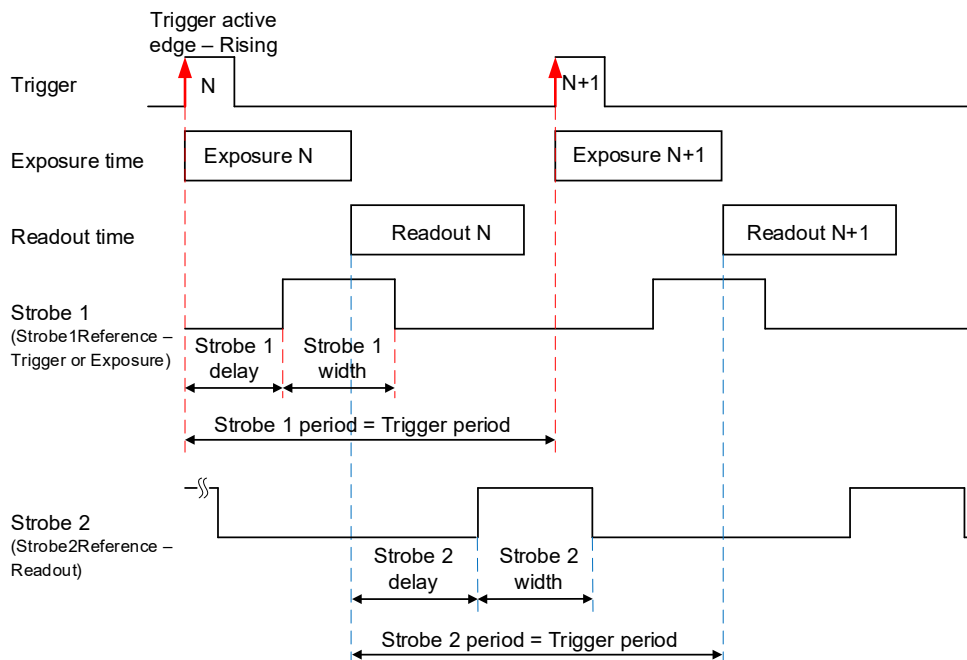

Strobe 1 is positioned with respect to the exposure start with a trigger delay. The camera is in Standard Trigger mode with Timed Exposure Control.

**Strobes Positioned with Respect to the Exposure Start
Standard Trigger Mode**

GenICam controls

TriggerMode: **On**
 TriggerOverlap: **Off**
 TriggerSource: **Line 1** (or Line2, Pulse Generator, Link Trigger)
 TriggerActivation: **Rising Edge** (or Falling Edge)
 TriggerDelay: **User-specified** (Min.= 10 μ s)
 TriggerFilterTime, TriggerDebounceTime: **set if applicable**

LineSelector: **Output1** (or Output2)
 LineSource: **Strobe1** (or Strobe2)
 Strobe1Reference: **Start of Exposure**
 Strobe1Enable: **On**
 Strobe1Width: **User-specified** (in μ s)
 Strobe1Delay: **User-specified** (in μ s)

Exposure Mode: **Timed**
For manual exposure control:
 Exposure Time: **User-specified** (Min.= 36 μ s; Max = Readout time)
 ExposureAuto: **Off**
For automatic exposure control (AEC):
 ExposureAuto: **Continuous** (or Once)

Parameters of the strobe signal
 Strobe period = Trigger period

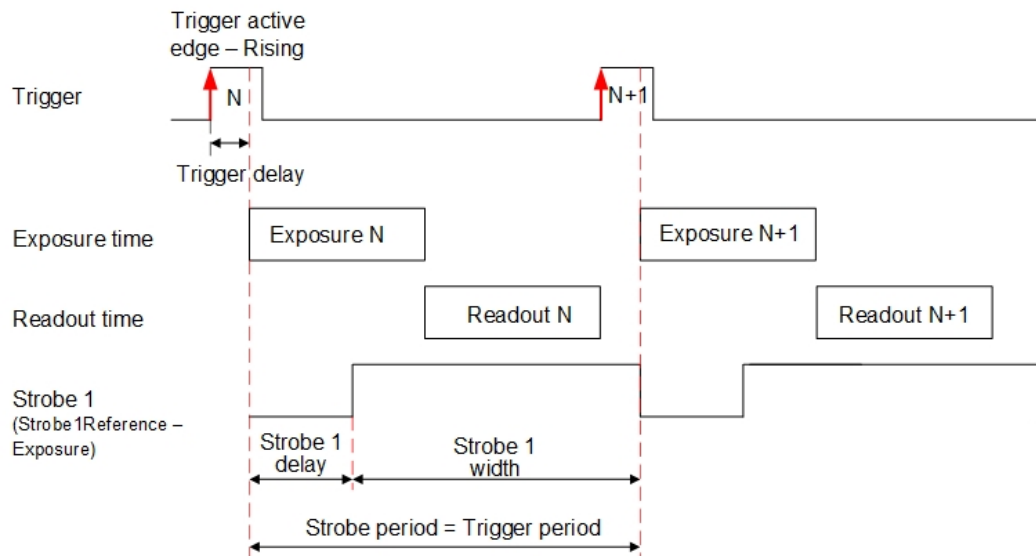

If your application requires activating a light source before the start of the exposure period, you can use *StrobeReference* and *StrobeDelay* settings to position the strobe to occur earlier than the exposure. To configure the strobe, follow the steps below:

1. Make sure that *TriggerMode* is **On** and *TriggerDelay* is set to a desired value in the Acquisition Control menu.
The Exposure starts with the delay after the trigger event.
2. Set *StrobeReference* to **Trigger**. The strobe occurs simultaneously with the trigger active edge.
3. Set *StrobeDelay* to a value lower than the *TriggerDelay* duration.
4. Set *StrobeWidth* to a desired value.

Strobes Positioned with Respect to the Trigger
Standard Trigger Mode

GenICam controls

TriggerMode: **On**
 TriggerOverlap: **Off**
 TriggerSource: **Line 1** (or Line2, Pulse Generator, Link Trigger)
 TriggerActivation: **Rising Edge** (or Falling Edge)
 TriggerDelay: **User-specified** (Min. = 10 μ s)
 TriggerFilterTime, TriggerDebounceTime: **set if applicable**

LineSelector: **Output1** (or Output2)
 LineSource: **Strobe1** (or Strobe2)
 Strobe1Reference: **Trigger**
 Strobe1Enable: **On**
 Strobe1Width: **User-specified** (in μ s)
 Strobe1Delay: **0** (no delay)
 Strobe2Reference: **Trigger**
 Strobe2Enable: **On**
 Strobe2Width: **User-specified** (in μ s)
 Strobe2Delay: **User-specified** (in μ s)

Exposure Mode: **Timed**
For manual exposure control:
 Exposure Time: **User-specified** (Min. = 36 μ s; Max = Readout time)
 ExposureAuto: **Off**
For automatic exposure control (AEC):
 ExposureAuto: **Continuous** (or Once)

Parameters of the strobe signal

Strobe period = Trigger period

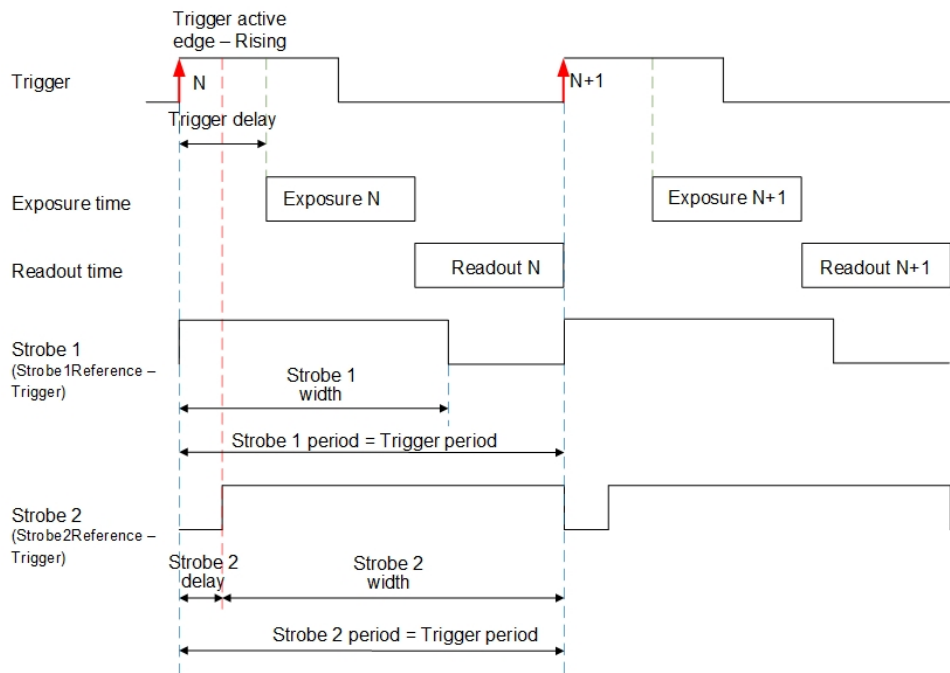

Area of Interest

For some applications, you might not need the entire image, but only a portion of it. To accommodate this requirement, the Cheetah camera allows you to create one Region of Interest (ROI), also known as an Area of Interest (AOI).

Horizontal and Vertical Window

Set the starting and ending point for each AOI independently in the horizontal direction (Horizontal Window) and the vertical direction (Vertical Window) by setting the window (H & V) offset and (H & V) size. The horizontal dimension is limited to multiples of 32 pixels, and the vertical dimension is limited to multiples of 4 pixels. In normal operation, the AOI defines the number of columns and rows output. The maximum horizontal window size (H) and the vertical window size (V) are determined by the camera's image full resolution.

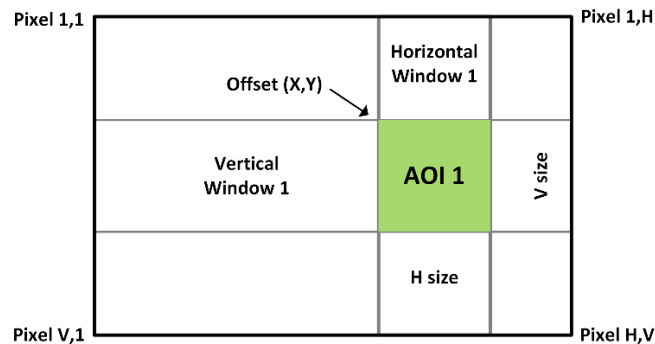

NOTE * For color cameras with AOI enabled, use an even number for Offset X and Offset Y to achieve proper color reconstruction and white balance.

Factors Impacting Frame Rate

The camera frame rate depends upon a number of variables including the exposure time, number of rows and columns in the AOI, and the bandwidth of the output interface.

AOI size: Camera frame rate increases by decreasing either the number of columns or number of rows read out. Changing the number of rows read out causes the largest change in frame rate.

Exposure Time: In free-running or Fast trigger mode, the camera overlaps the exposure time and image readout so frame rate has no dependence on exposure time. In Standard trigger mode, however, the exposure and readout time do not overlap, and long exposure times will decrease frame rate.

Line time: This is the time required to read out one line from CMOS sensor. Increasing the line time decreases the camera frame rate and extends exposure time. Please note that the extended line time decreases bandwidth usage and requires more frame grabber's buffer space.

Decimation: The camera supports both binning and sub-sampling decimation to reduce the output resolution. Binning and sub-sampling increase the sensor frame rate. However, sub-sampling offers the largest frame rate improvement by reducing the number of rows and columns read out from the image sensor. Binning and sub-sampling provide about a 2x to 3x increase in frame rate.

Binning and Sub-Sampling Decimation

Binning

The principal objective of the binning function is to reduce the image resolution with better final image quality than a subsampling function. Binning reduces the output resolution by summarizing several pixels together and has the advantage of reducing aliasing and noise, which increases signal-to-noise ratio (SNR). Subsampling – as opposed to binning – has the advantage of increasing the output frame rate by reducing the number of rows read out, but also introduces aliasing in the final image. Subsampling, however, increases the output frame rate more than binning.

The following graphic illustrates the concept of 4:1 binning for a monochrome image sensor. The values of pixels P1, P2, P3 and P4 are summed together resulting in a single larger pixel. The binning feature can be used on the full resolution image or within any area of interest.

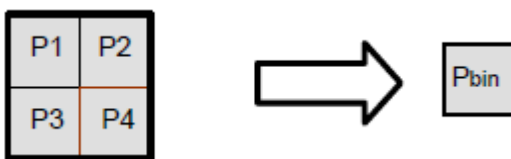

NOTE ⚠ You cannot apply both binning and subsampling decimation simultaneously.
Color cameras do not support binning.

Sub-Sampling Decimation

Sub-sampling reduces the number of pixels output by reducing the output frame size but maintains the full field of view. If an area of interest (AOI) is selected, then the field of view of the AOI is maintained.

The cameras employ a “keep one pixel, skip one pixel” sequence. When enabled in both x and y, every other pixel within a line is retained, and every other line within the image is retained.

Monochrome subsampling:

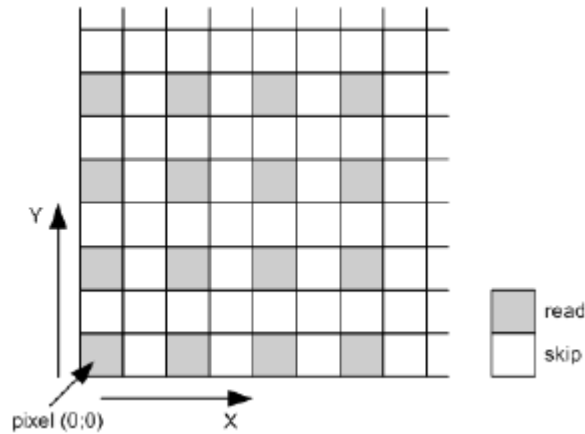

Color subsampling:

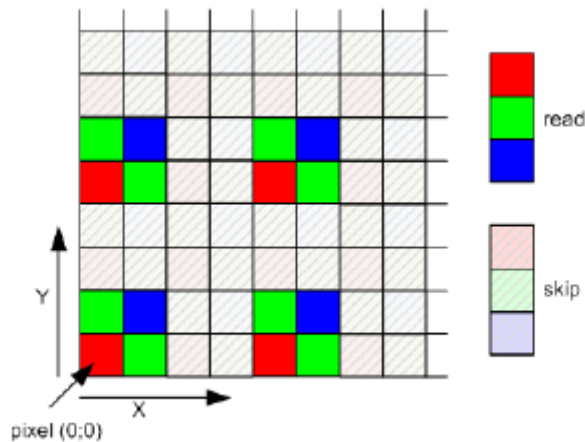

Transfer Function Correction

The user-defined LUT (Lookup Table) feature transforms any 12-bit video data into any other 12-bit value. For the 10-bit sensor digitization, the camera multiplies the 10-bit pixel data by 4 to get 12-bit pixel data for input into the 12-bit LUT. After the 12-bit LUT transforms the data, the camera divides the 12-bit data by 4 to get 10-bit pixel values for output to the camera interface.



The camera supports a Gamma control feature and four separate LUTs. All LUTs are available for modifications. You can generate and upload a custom LUT using the Imperx Upload Utility (see [Uploading the LUT File](#)).

You can control the image luminance by setting the Gamma control or/and by enabling one of the LUT. When both Gamma and LUT enabled, the camera implements the Gamma control first and then applies the LUT.

Gamma Control

The camera’s built-in processing engine enables adjustments to the luminance (brightness) of an image on the monitor. Using Gamma control, you can stretch or compress the image luminance by adjusting a pixel value (pixel intensity).

By default, Gamma is equal to 1 and does not affect the image luminance. The output signal equals the input signal. To enable the Gamma control, set it to any other value.

If Gamma control is enabled, the video signal is transformed by a non-linear function as shown in the following formula.

$$\text{Output signal (ADU with 12 bpp)} = 4095 * \left[\frac{\text{LUT input}}{4095} \right]^{\text{Gamma}}$$

where Gamma is a power applied to the pixel value, from 0.00 to 4.00, with a step of 0.01. It is not a gamma of a display.

Factory LUTs

Each LUT consists of 4096 entries, with each entry being 12 bits wide. LUT1 and LUT3 are factory programmed with a standard Gamma 0.45, LUT2 and LUT4 are pre-programmed with negative LUT ($LUT_{OUTPUT} = 4095 - LUT_{INPUT}$).

The Gamma 0.45 LUT uses the following formula:

$$LUT_{OUTPUT} \text{ (ADU with 12 bpp)} = 4095 * [(LUT_{INPUT}/4095)^{0.45}]$$

For example, if the LUTINPUT is 1024 ADU (12 bpp), then LUTOUTPUT is $4095 * (1024/4095)^{0.45} = 2195$.

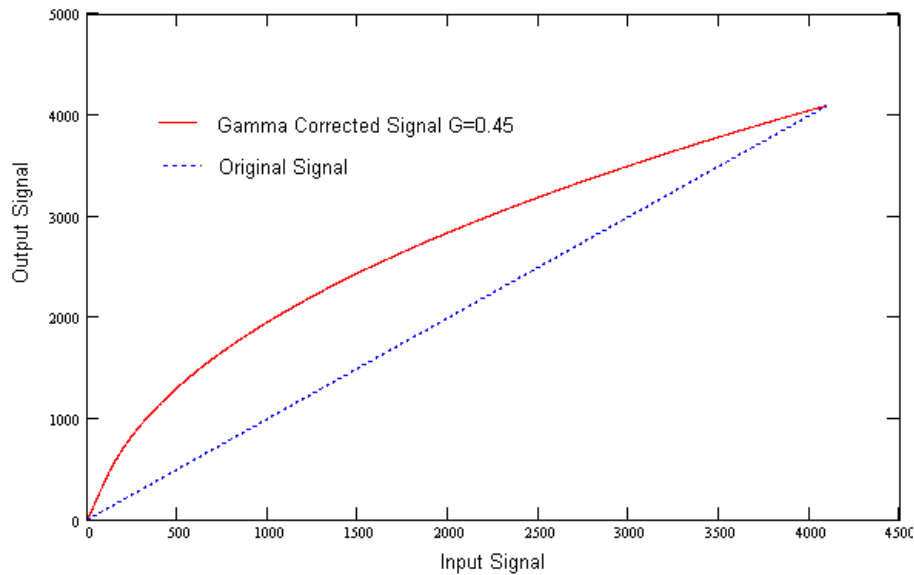

User Defined LUT

You can define any 12-bit to 12-bit transformation as a user LUT and upload it to the camera using Imperx Upload Utility (see [Uploading the LUT File](#)). You can specify a transfer function to match the camera’s dynamic range to the scene’s dynamic range. There are no limitations to the profile of the function. The LUT must include all possible input values (0 to 4095) (refer to the [Appendix C: Look Up Tables](#)).

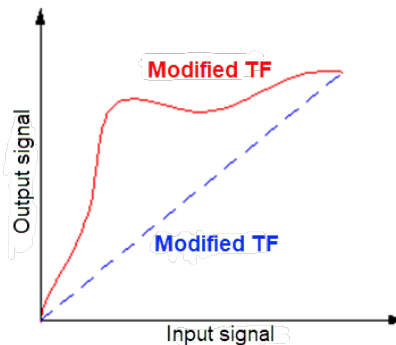

Hot and Defective Pixel Correction

A CMOS imager is composed of a two-dimensional array of light sensitive pixels. In general, most of the pixels have similar sensitivity. However, some pixels deviate from the average pixel sensitivity and are called *defective pixels* and *hot pixels*.

Defective pixels (also known as *dead pixels*) – these are pixels whose sensitivity deviates due to fluctuations in the CMOS manufacturing process and materials. Two types of defective pixels are possible:

- **Dark** – a pixel whose sensitivity is lower than the sensitivity of the adjacent pixels. In some cases, this pixel will have no response (completely dark).
- **Bright** – a pixel whose sensitivity is higher than the sensitivity of the adjacent pixels. In some cases, this pixel will have full response (completely bright).

Hot pixels – these are pixels that in normal camera operation behave as normal pixels (sensitivity equal to one of the adjacent pixels). But during long exposures or at elevated temperatures, the pixel becomes far brighter than the average of the pixels surrounding it. In some cases, the pixel becomes so bright that it saturates.

At the factory, final testing identifies and stores maps of both hot and defective pixels. Enabling *DefectPixelCorrection* and *BadPixelCorrection* using the Factory option, corrects hot and defective pixels using the Factory map.

The camera employs *static* pixel maps to correct up hot and defective pixels. During factory testing, engineers identify the coordinates of hot and defective pixels. They create a map file listing the pixel coordinates of these pixels by row and column, and the camera corrects the hot and defective pixels found at these coordinates. The map file downloads into the camera's non-volatile memory.

When Factory or User correction is enabled, the camera compares each pixel's coordinates with entries in the pixel map. If a match is found, the camera corrects the defective pixel.

You can create your own Hot Pixel Map (HPM) or Defective Pixel Map (DPM) file and upload it using the Imperx Upload Utility application (refer to the [Appendix B](#) for more information).

Flat Field Correction

The camera uses a factory installed flat field correction (located in FFC0) algorithm to correct some of the image sensor's non-uniformity. You can upload your own FFC table to one of the FFC1 – FFC8 tables using Imperx Upload Utility. While not recommended, you can disable the FFC.

Test Image Pattern

The camera can output several test images to verify the camera’s general performance and connectivity to the computer. This ensures that all the major modules in the hardware are working properly and the connection between your computer and camera is synchronized, that is, the image framing, output mode, communication rate, and so on are properly configured. Note that test image patterns do not exercise and verify the image sensor functionality. The following table show a list of test images available.

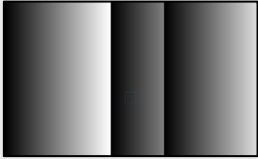
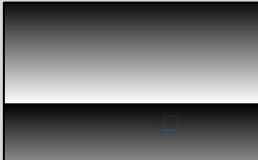
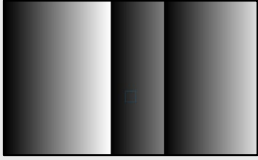
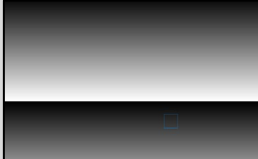
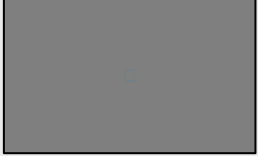
Test pattern	Description	Pattern
Off	Image is coming from the sensor	-
GreyHorizontalRamp	Image is filled horizontally with an image that goes from the darkest possible value to the brightest	
GreyVerticalRamp	Image is filled vertically with an image that goes from the darkest possible value to the brightest	
GreyHorizontalRampMoving	Image is filled horizontally with an image that goes from the darkest possible value to the brightest and that moves horizontally from left to right at each frame.	
GreyVerticalRampMoving	Image is filled vertically with an image that goes from the darkest possible value to the brightest and that moves vertically from top to bottom at each frame.	
FlatField	Displays a constant grey value.	

Automatic White Balance

The camera provides white balance options for controlling image color under different lighting conditions. You can load the camera with your preferred white balance coefficients or let the camera determine the color coefficients one time or continuously (auto).

AWB Mode	Description
Off	AWB is disabled and a manual control is on. The camera applies the correction coefficients you enter using the <i>BalanceRatioSelector</i> and <i>BalanceRatio</i> controls.
Once	The camera analyzes one image frame, calculates only one set of coefficients, and corrects all subsequent frames with this set of coefficients.
Continuous	The camera analyzes every frame, derives a set of correction coefficients for each frame, and applies them to the next frame. You can set a tracking speed to be from 1 to 64 with 1 being the slowest and 64 the fastest.

To compensate for color shift, the Green channel is used as a reference and the Red and Blue channel gains are changed to match the Green channel. For example, to increase the Red channel gain by 75%, set the Red *BalanceRatio* to 1.75x. The camera applies 75% more gain to the Red channel than to the Green.

Manual Control over the Correction Coefficients (AWB mode: Off)

To adjust the Red and Blue channel gain coefficients with respect to Green (the reference), use the control *BalanceRatioSelector* to point to the color (Red or Blue) whose gain should be adjusted. Then *BalanceRatio* control is used to set a gain value between 0.25x to 4.00x for the selected color. The Green channel gain is always set to 1.

BalanceRatio value	Red/Blue channel gain
from 0.25x to 0.99x	the channel gain decreases
from 1.01x to 4.00x	the channel gain increases
1.00x	the gain does not change

To disable Auto-White Balance, set *BalanceRatio* to 1.00x for both Red and Blue channel gains.

EXAMPLE

To set Blue channel gain with respect to Green to 2x and set Red channel gain to 0.8x:

1. On **AnalogControl** panel, set *BalanceWhiteAuto* to **Off**.
2. Set *BalanceRatioSelector* to **Blue**.
3. Set *BalanceRatio* to 2.00.

▼ AnalogControl	
Gain	7.00
GainAuto	Off
BlackLevel	60.00
SensorBlackLevelRecomended	<input checked="" type="checkbox"/> True
BlackLevelAuto	Continuous
Gamma	1.00
DigitalGain	1.00
DigitalBlackLevel	0.00
2 BalanceRatioSelector	Blue
3 BalanceRatio	2.00
1 BalanceWhiteAuto	Off

4. Set **BalanceRatioSelector** to Red.

5. Set **BalanceRatio** to 0.80.

4 BalanceRatioSelector	Red
5 BalanceRatio	0.80
BalanceWhiteAuto	Off

6. Save this configuration to one of the User Sets (see section [Configuration Memory](#)).

AWB mode: Once

For the best color reproduction when the source has a stable spectral output, Imperx suggests illuminating a uniformly grey card with the intended source then using the **Once** option to determine the coefficients and then saving these coefficients into the camera and saving this configuration to one of the User Sets.

To get the best white balance coefficients when the spectral source is constant:

1. Image a grey or white target over the camera's entire field of view using the intended lighting source.
2. Select **Once** mode for the *BalanceWhiteAuto*. The Red and Blue coefficients appear in the *BalanceRatio* area.
3. Save this configuration to one of the User Sets (see section [Configuration Memory](#)).

AWB mode: Continuous

The camera automatically adjusts the Red and Blue channel gains when *BalanceWhiteAuto* is set to **Continuous**.

Configuration Memory

The camera has built-in configuration memory divided into six segments: Work Space, Factory Space (Default), User Space #1, #2, #3 or #4. The Work Space segment contains the current camera settings while the camera is powered up and operational. All camera registers are in this space. You can program these registers and change the camera configuration through these registers.

The Work Space is RAM based. All camera registers clear upon camera power-down. The Factory Space (Default) segment is ROM based, write protected, and contains the default camera settings. This space is available for read operations only. User Space #1, #2, #3 and #4 are non-volatile, flash-based, and used to store up to four user defined configurations or User Sets. Upon power up or software reset, the camera firmware loads the Work Space registers from the Factory Space (Default), User Space #1, #2, #3 or #4 as determined by a User Set Default Selector setting. At any time, you can instruct the camera to load its Work Space with the contents of the Factory Space, User Space #1, #2, #3 or #4 by first using the User Set Selector to point to the desired User Set then using the User Set Load command. Similarly, you can instruct the camera to save the current Work Space settings into either User Space #1, #2, #3 or #4 by using the User Set Selector to point to the desired User Set and then using the User Set Save command.

The non-volatile parameter Flash memory also contains the Bad Pixel Map (BPM), Defective Pixel Map (DPM), 8 Flat Field Correction (FFC) tables and 4 LUTs which you can load to the camera's internal memory upon enabling the corresponding camera feature. You can create custom LUT tables using the Imperx IPX Toolkit utility and upload these tables to the parameter Flash using the Imperx Upload Utility. Both the IPX Toolkit and IPX Upload Utility are available from the Imperx website <https://www.imperx.com/>.

CXP Link Customization

The Cheetah CXP camera provides two CXP channels with 6.25 Gbps speed per each channel. If your application requires using lower speed and/or one channel, you can re-program the camera.



To re-program your CXP camera, use a frame grabber that features at least two CXP channels.

To customize the CXP link and/or speed of your camera, follow the steps below.

1. In the **Transport Layer Control** menu, select **CoaXPressCustomization** and set **CustomCxpLinkConfiguration** to a new value.

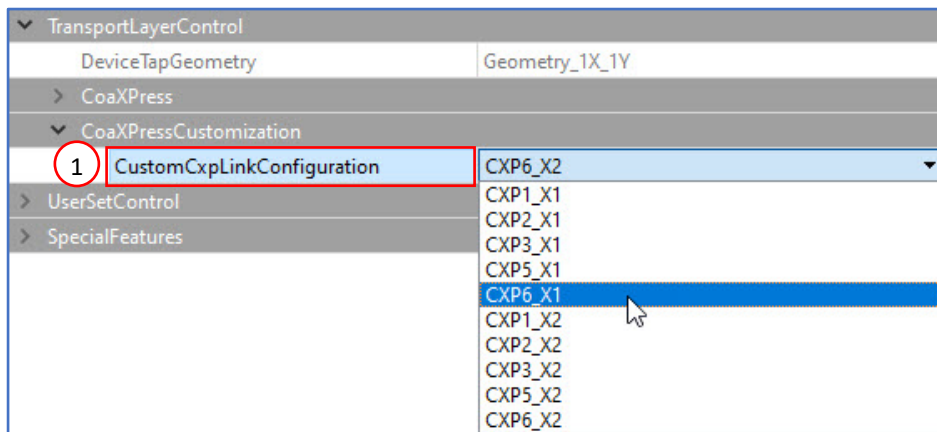

You can select the number of channels (X1 – one CXP channel, X2 – two CXP channels) and speed (Gbps) per one channel:

CustomCxpLinkConfiguration setting	Number of CXP channels (number of CXP cables)	Speed per one channel, Gbps	Total Speed, Gbps
CXP1_X1	1	1.250	1.250
CXP2_X1	1	2.500	2.500
CXP3_X1	1	3.125	3.125
CXP5_X1	1	5.000	5.000
CXP6_X1	1	6.250	6.250
CXP1_X2	2	1.250	2.500
CXP2_X2	2	2.500	5.000
CXP3_X2	2	3.125	6.250
CXP5_X2	2	5.000	10.000
CXP6_X2	2	6.250	12.500

- In the **User Set Control** menu, point to one of the User Sets to store your configuration using the *UserSetSelector*.
The options are UserSet0, UserSet1, UserSet2, or UserSet3. The Default is a factory configuration that cannot be changed.

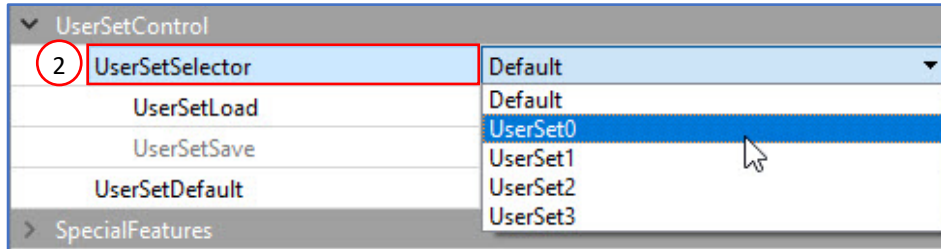

- Execute **UserSetSave** command to save your configuration to the camera’s non-volatile memory.
- Select your User Set (must be the same as in step 2) in **UserSetDefault** menu.
The camera loads and activates this User Set upon the next reset or upon power-up.

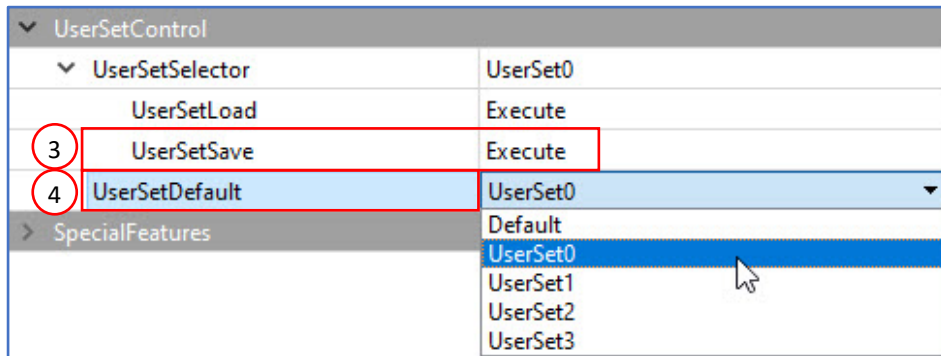

- Power-cycle the camera for the changes to take effect.
- If applicable, disconnect the camera from the frame grabber used for re-programming and attach it to the one that determined by your design (for instance, to a single-port frame grabber).

Canon Lens Control

Make sure that a switch on your Canon EOS EF lens is set to Auto (AF), and Visibility is set to Guru on a frame grabber’s application screen.

The camera initializes the lens upon power cycling. Check **Lens Controller Status** parameter. If the status is `InitLens_Done`, the initialization was successfully completed, and you can start adjusting the lens. If the initialization failed, issue **InitLens** command on Controller Setting screen.

Focus Control

1. For the camera to learn a range of the Canon lens’s Focus Encoder, issue the following sequence of commands:
 - a. Issue the *Canon Focus Near-Full* command.
 - b. Issue the *Reset Focus Encoder* command.
 - c. Issue the *Canon Focus Far-Full* command.
 - d. Issue the *Get Focus Encoder Status* command.
 - e. Issue the *Focus Set Max* command. The *Focus Max* parameter will be automatically set to the maximum value.

Focus	
NearFull	Execute a.
FarFull	Execute c.
FocusStepValue	255
NearStep	Execute
FarStep	Execute
FocusReqPosition	0
SetFocusPosition	Execute
FocusMax	0
FocusSetMax	Execute e.
FocusEncoderStatus	10000
GetFocusEncoderStatus	Execute d.
ResetFocusEncoder	Execute b.

2. Set *FocusReqPosition* to a desired value.
3. Issue the *SetFocusPosition* command.
FocusEncoderStatus will change.

Focus Encoder is a Hall effect sensor and is not perfectly precise, so *FocusEncoderStatus* values can vary. It does not provide sufficiently accurate location information to set lens focus after power cycling. Error tends to increase with a number of focus movements. Once the lens is focused, it will retain focus after repeated power cycling.

Canon *FocusEncoderStatus* is a signed value (2's complement). Negative values can result if the Focus Encoder position is close to the Near Full position. For example, a value of 65352 means negative 184 or 184 steps past the Near Full Position.

Iris Control

A Canon EF EOS lens provides an iris range in raw units. A camera reads out an iris range from a Canon lens in raw units upon issuing the *GetIrisRange* command. Each time the iris is changed, the camera calculates and returns the *CurrentFNumber* using the following formula:

$$\text{CurrentFNumber} = \text{Sqrt}(2)^{\lceil (\text{Raw unit}/8) - 1 \rceil}$$

For example, if Raw unit = 32, then CurrentFNumber = 2.83.

Using XML features *IrisRequestedPositionRaw* and *SetIrisPosition* you can set an aperture to a required value. The aperture will be changed with *IrisStepValue* until it is greater than or equal to the target position in raw units.

▼ Iris	
<i>IrisRequestedPositionRaw</i>	22
<i>SetIrisPosition</i>	Execute
<i>CurrentFNumber</i>	1.83401
<i>OpenIrisFull</i>	Execute
<i>CloseIrisStep</i>	Execute
<i>OpenIrisStep</i>	Execute
<i>IrisStepValue</i>	1
<i>GetIrisRange</i>	Execute
<i>IrisMin</i>	22
<i>IrisMax</i>	80
<i>IrisRange</i>	0x50161616

Image Sensor Technology

General Information

A CMOS camera is an electronic device for converting light into an electrical signal. The C4440, C5440, and C6440 cameras contain Sony Pregius CMOS (Complementary Metal-Oxide Semiconductor) image sensors with 3.45-micron square pixels. The sensors have extremely low dark current and no visible fixed pattern noise, which has been the bane of traditional CMOS image sensors.

The Sony CMOS sensor consists of a two-dimensional array of sensitive elements called silicon photodiodes, also known as pixels. The photons falling on the CMOS surface create photoelectrons within the pixels. The number of photoelectrons is linearly proportional to the light level. Although the number of electrons collected in each pixel is linearly proportional to the light level and exposure time, the number of electrons created in the pixel during any fixed time period varies with the wavelength of the incident light.

When the camera reaches the desired exposure time, it shifts the charges from each pixel photodiode onto a storage register within the pixel, reads out one row at a time digitizing each pixel at 10 or 12 bits. The user can selectively output the most significant 8, 10 or 12 bits from each pixel with an impact to camera's frame rate. Frame time, or read-out time, is the time interval required for all the pixels to be read out of the image sensor. In non-triggered or fast trigger mode, while reading out the image from the storage registers within each pixel, the camera captures the next image. The exposure ends just as the readout of the previous frame ends and the next frame begins.

The Sony CMOS image sensor digitizes each pixel within a row simultaneously. This allows for more settling time, which lowers the overall noise floor and provides improved sensitivity. The low noise floor, combined with a reasonably large pixel charge capacity and extremely low dark current, translates into a large dynamic range of 71 dB (12-bits) or 12 F-stops.

The sensor allows you to apply up to 48 dB of gain to the image. The first 24 dB of gain is analog gain and some improvement in noise performance may result. The camera applies the last 24 dB of gain digitally, which affects both signal and noise equally. Additional digital gain (up to 12 dB) can also be applied using the Digital Gain control.

Spectral Sensitivity

A set of color filters (red, green, and blue) arranged in a Bayer pattern over the pixels generates color images. The starting color is Red for SONY Pregius image sensors and follows the pattern: red, green, red, green, red, ... on row 1 and green, blue, green, blue, green, ... on row 2 and so on. The color and monochrome spectral responses of the sensors used in Cheetah cameras can be found in [Appendix A](#).

Appendix A: Spectral Response

Cheetah C4440 Spectral Response

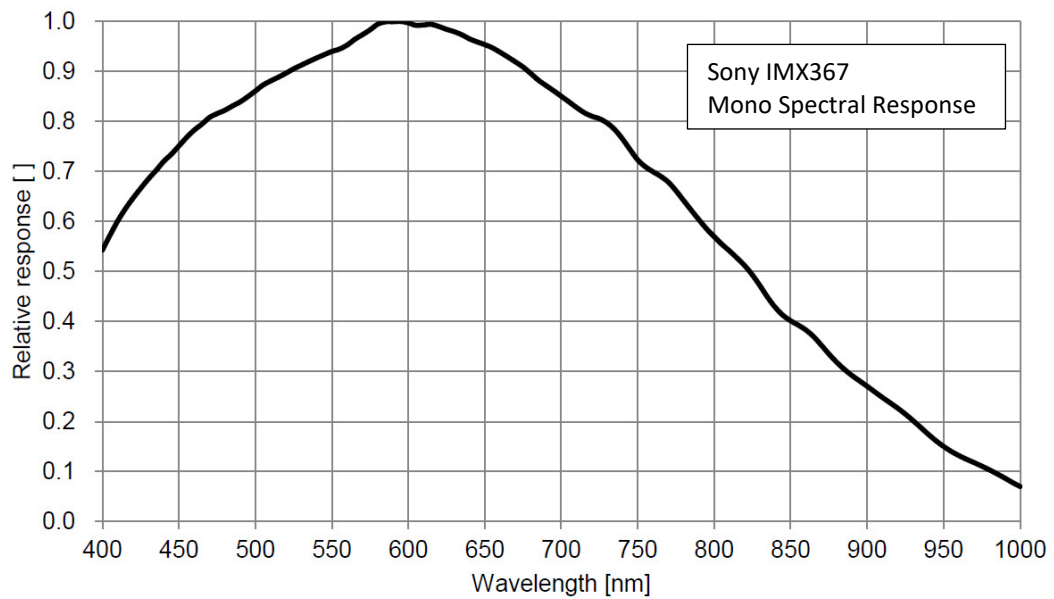
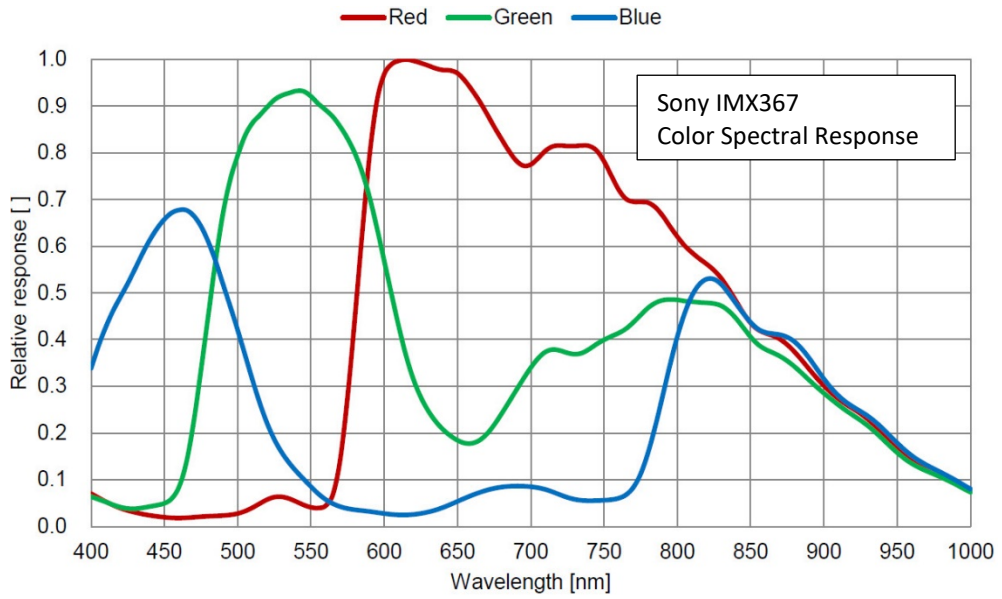

Cheetah C5440 Spectral Response

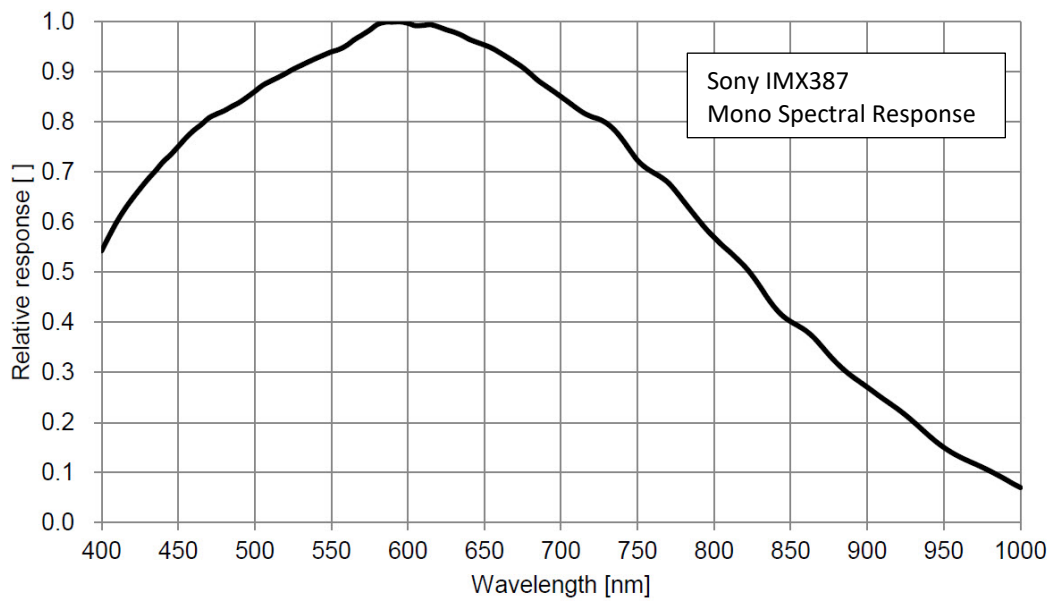
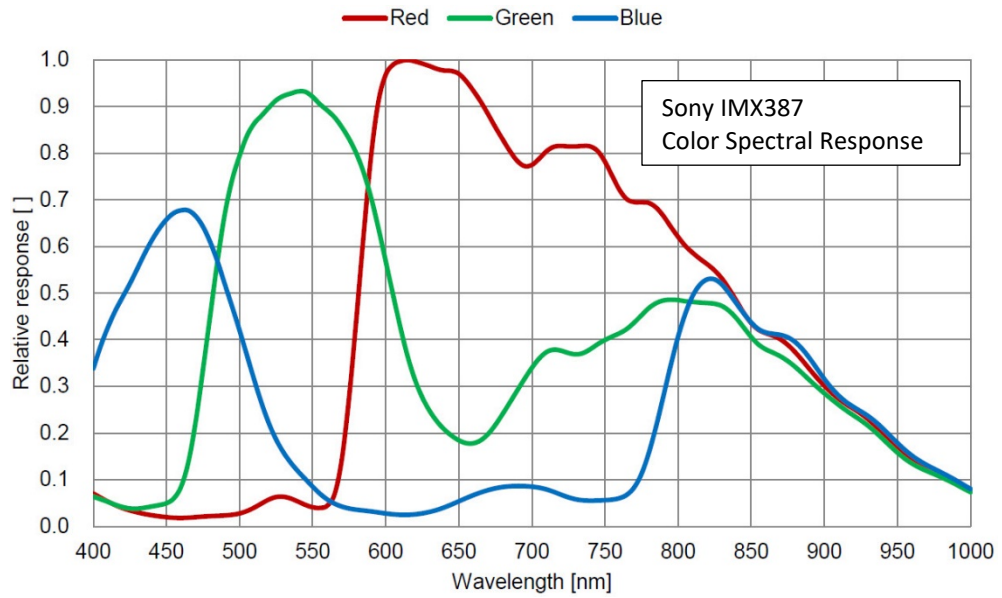

Cheetah C6440 Spectral Response

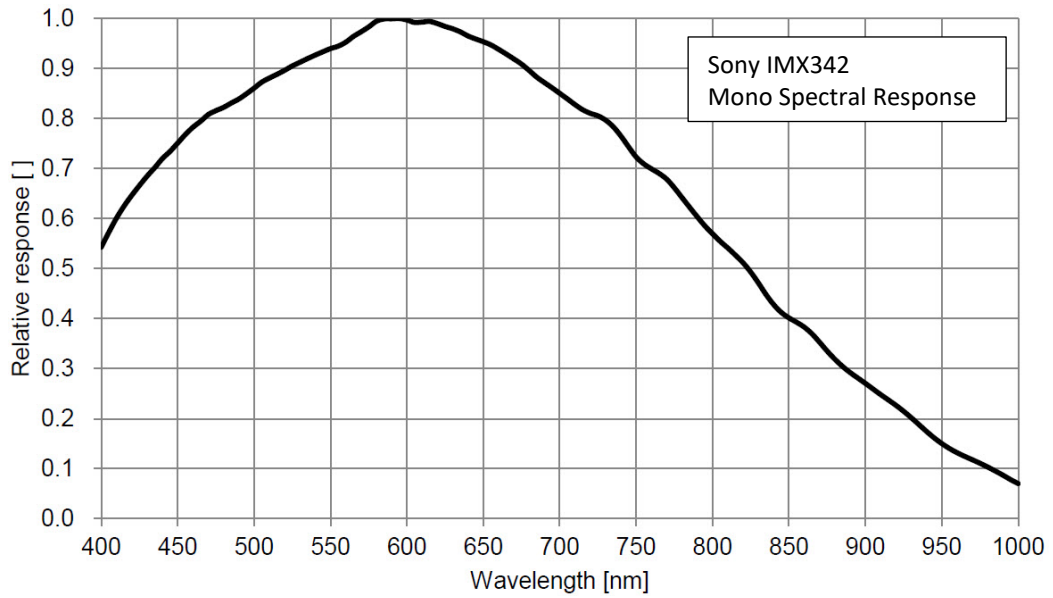
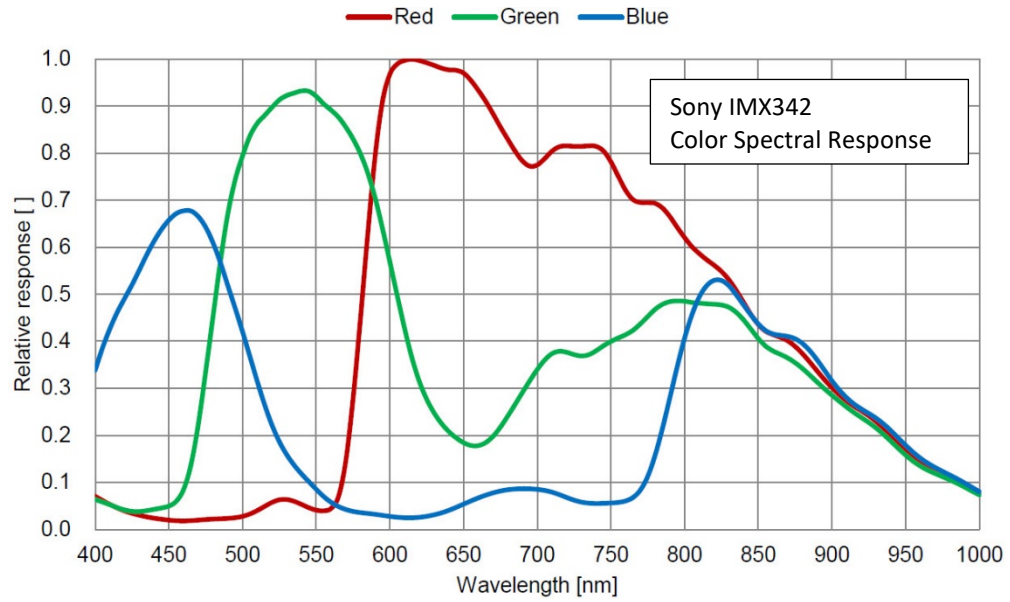

Appendix B: Creating Hot and Defective Pixel Correction Maps

Overview

Hot Pixel Correction and Defective Pixel Correction work with predetermined and preloaded Hot and Defective pixel maps.

Hot Pixel Map (HPM) and Defective Pixel Map (DPM) are uploaded into the camera's non-volatile memory.

You can edit the original (factory installed) HPM / DPM file and upload it into the camera to fit the unique requirements of your operating environment or camera use.

Editing HPM / DPM Files

You can edit HPM and DPM files in Microsoft Notepad or any other editing software. The file is a simple text file that looks like this:

```
-- Defective Pixel Map,  
-- Date: 11.26.2019,  
-- Model#: CXP-C6440M,  
-- Serial#: LAC001,  
:Table,  
-- Column (X) , Row (Y)  
    5683,155  
    3091,332  
    3532,893  
    650,1017  
    701,1017  
    1712,1053  
    914,1067
```

Pixel maps have two main sections: a header and a table. The header section is a free text area of up to 256 ASCII characters. Each line of the header section must be terminated with a comma. The table section of the file contains an array of lines with each line containing an X (column number) value followed by a comma and a Y (row number) value.

All pixels are listed in the HPM or DPM in order of increasing Y (row) location. If there are multiple hot or defective pixels in the same row (Y location is identical for both defective pixels), the listing is in order of increasing X (column) location.

The maximum number of pixels in the DPM list is 1024 and in HPM list is 4096.

To edit original DPM or HPM file, you need to identify defective or hot pixels, locate and adjust their coordinates, and accurately place pixels' coordinates into the pixel map.

Finding Defective Pixels

To see the defective pixels that are not in the factory DPM:

1. Make sure that the *DefectPixelCorrection* is set to Factory in the Data Correction menu of the software GUI.
The camera corrects the known pixel defects automatically.
2. Make sure that *TriggerMode* and *ExposureMode* are set to Off, and the camera resolution is set to maximum.
3. Capture an image with a uniform light source illuminating the sensor at about 50% ADU capacity (~2000 for 12-bit, ~500 for 10-bit, ~130 for 8-bit modes).
4. Identify any visible defective pixel and add them to the DPM as described in [Locating and adding pixel coordinates](#).

To see all the defective pixels, including those in the factory DPM:

1. Set *DefectPixelCorrection* to Off in the Data Correction menu.
2. Make sure that *BadPixelCorrection* is set to Factory.
3. Repeat steps 2–4 of the previous procedure.

TIP

To obtain the factory DPM file, contact Imperx technical support at:

Email: support@imperx.com

Toll Free: 1 (866) 849-1662 or (+1) 561-989-0006

Fax: (+1) 561-989-0045

Visit our website: www.imperx.com.

To create an HPM that contains all the hot pixels, see [Creating a DPM Using Imperx Toolkit](#).

To upload a new DPM into the camera, see [Uploading DPM / HPM Files](#).

Finding Hot Pixels

To see the hot pixels that are not in the factory HPM:

1. Make sure that *BadPixelCorrection* is set to Factory in the Data Correction menu.
The camera corrects the known hot pixels automatically.
2. Set the longest exposure time and slowest frame rate expected.
3. Put the lens cap on the camera.
4. Run the camera for at least 45 minutes at ambient temperature around 18–22 °C or higher.
5. Capture an image (or series of images).

6. Identify all visible hot pixels and add them to the HPM as described in [Locating and adding pixel coordinates](#).

To see the hot pixels included in the factory HPM:

1. Set *BadPixelCorrection* to Off in Data Correction menu.
2. Make sure that *DefectPixelCorrection* is set to Factory.
3. Repeat steps 2–6 of the previous procedure.

TIP ⓘ

To obtain the factory HPM file, contact Imperx technical support at:

Email: techsupport@imperx.com

Toll Free: 1 (866) 849-1662 or (+1) 561-989-0006

Fax: (+1) 561-989-0045

Visit our website: www.imperx.com.

To create an HPM that contains all the hot pixels, see [Creating an HPM Using Imperx Toolkit](#).

To upload a new DPM to the camera, see [Uploading DPM / HPM Files](#).

Locating and adding pixel coordinates

Follow the steps below to find first pixel coordinates, locate and adjust defective pixel coordinates, and accurately place defective pixel coordinates into the pixel map.

STEP 1: Find the First Pixel Coordinates

Your frame grabber's first pixel coordinates can affect the location accuracy of defective pixel coordinates. So, you must find the image sensor's first pixel coordinates and potentially adjust the defective pixel coordinates based on your findings.

Click the first pixel at the upper most left corner of the screen to find your frame grabber's first pixel X, Y coordinates.

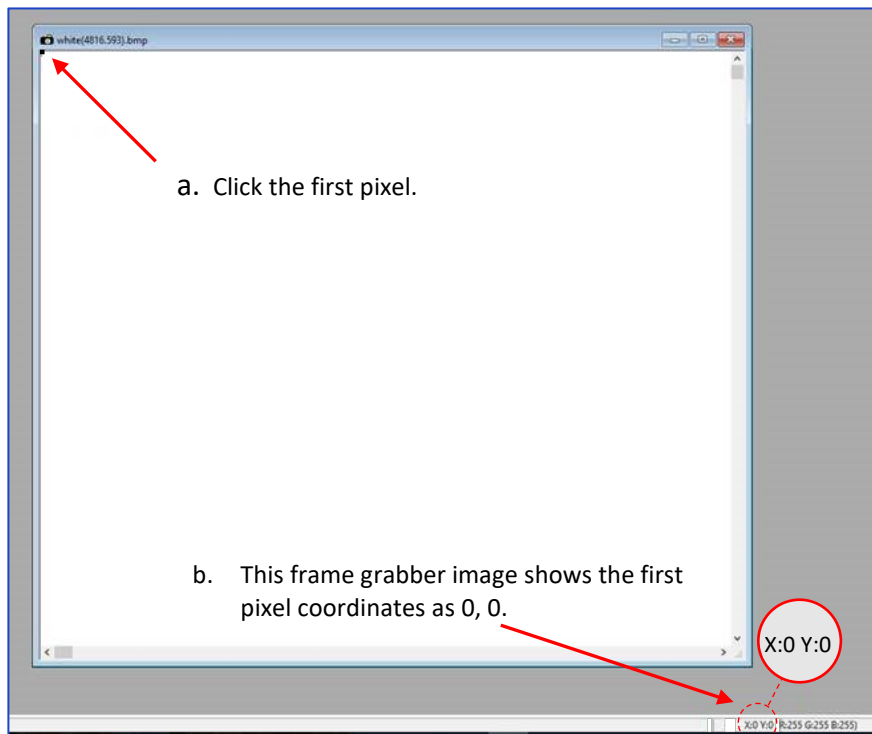

The coordinates will be either 0, 0 or 1, 1:

- If your frame grabber's first pixel coordinates are 0, 0, you should add 1 to both the X and Y coordinates of the defective pixel.
- If the first pixel coordinates are 1, 1, do not add 1 to either coordinate.

STEP 2: Find Defective Pixel Coordinates

Click the defective pixel to find its X, Y coordinates.

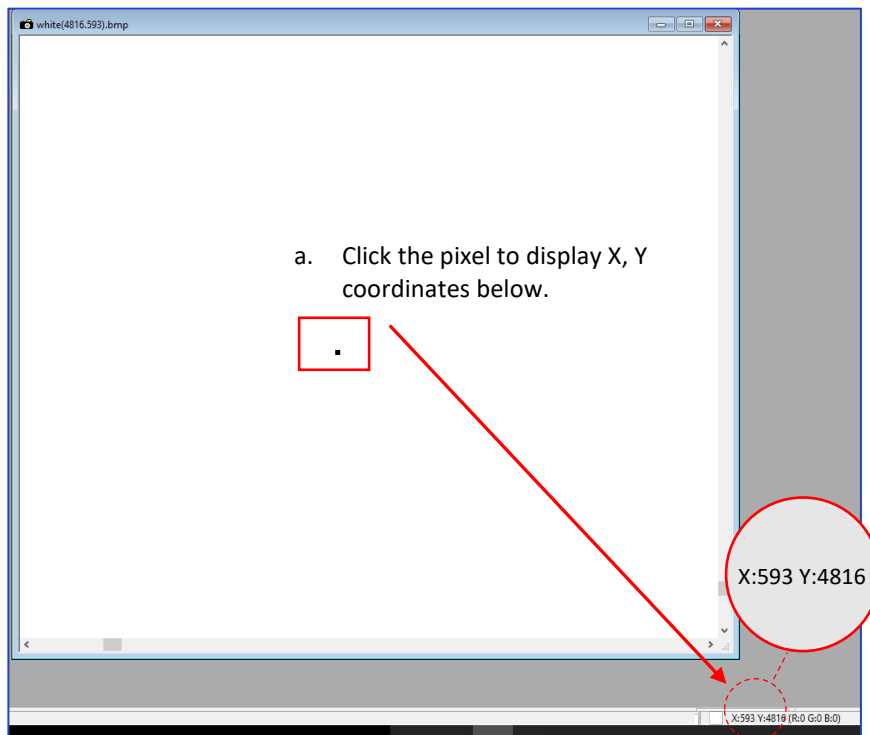

The coordinates are 593, 4816, where X (Column) = 593 and Y (Row) = 4816.

IMPORTANT: Frame grabbers from different manufacturers may display pixel location coordinates in different order, for example:

X (Column), Y (Row) or,
X (Row), Y (Column).

You must put defective pixel coordinates into the pixel correction map file in this order:
X (Column), Y (Row).

If your frame grabber identifies pixel coordinates by X (**Row**), Y (**Column**), you must transpose the coordinates to X (**Column**), Y (**Row**) before entering them into the pixel map files. For example, if the 593, 4816 coordinates in the screen above had been displayed in this order, where X:593 is a row and Y:4816 is a column, you would have had to transpose the coordinates to 4816, 593.

STEP 3: Adjust Defective Pixel Coordinates

As described in **STEP 1**, if the first pixel coordinates are 0, 0, you must adjust the defective pixel coordinates by adding 1 to both coordinates as shown in the following:

$$593 (+1), 4816 (+1) = 594, 4817$$

- If the frame grabber pixel coordinates are Column (X), Row (Y), then go to **STEP 4**.
- If the frame grabber pixel coordinates are Row (X), Column (Y), then transpose the coordinates to the form Column, Row and then go to **STEP 4**.

STEP 4: Add Defective Pixel Coordinates to Defective Pixel Map

Place the defective pixel coordinates in the Defective Pixel Map file in ascending (increasing) numerical order of the Y (row) coordinate. The value of all Y coordinates should progressively increase as you look down the list of X, Y coordinates.

Example 1: Different Y coordinates	Example 2: Identical Y coordinates
<pre>-- Defective Pixel Map, -- Date: 4.12.2018, -- Model#: CXP-C5180M-RF, -- Serial#: LAC001, :Table, -- Column (X) , Row (Y) 701, 1017 100, 1018 4325, 1019 2241, 1020 458, 1021 1712, 1053 914, 1067 3954, 1546 2516, 1670 3451, 3331 1111, 4149 95, 4364 594, 4817 433, 4828 205, 4899</pre> <p style="border: 1px solid red; padding: 2px; display: inline-block;">Row coordinates are in ascending order (increasing Y values).</p>	<pre>-- Defective Pixel Map, -- Date: 4.12.2018, -- Model#: CXP-C5180M-RF, -- Serial#: LAC001, :Table, -- Column (X) , Row (Y) 650, 1017 698, 1017 701, 1017 100, 1018 4325, 1019 2241, 1020 458, 1021 1712, 1053 f914, 1067 3954, 1546 2516, 1670 3451, 3331 1111, 4149 95, 4364 433, 4828 205, 4899</pre> <p style="border: 1px solid red; padding: 2px; display: inline-block;">Column coordinates are in ascending order (increasing X values).</p>

As shown in the **Example 1** above, the Y coordinate of **594, 4817** is higher than **4364** and lower than **4828**. Do not add defective pixel coordinates at the end of the list unless the Y coordinate is the highest of all Y values.

NOTE ⚠ If adding a defective pixel with a Y location identical to one or more other defective pixels, insert its coordinates based on the order of increasing X location.

As shown in the **Example 2** above, the Y coordinate of **698, 1017** is identical to two other defective pixels. Place its coordinates between **650, 1017** and **701, 1017** because its X location (698) is higher than 650 but lower than 701.

STEP 5: Save your DPM/HPM

- Save your Defective Pixel Map with the file extension .dpm.
- Save your Hot Pixel Map with file extension .hpm.

Creating a DPM/HPM Using a Text Editor

You can create your own DPM and HPM files using any ASCII text editor, such as Notepad or similar. Alternatively, any spreadsheet program (i.e. Microsoft Excel) can be used by converting the spreadsheet into a comma delimited (.csv) file. In either case, the file must be renamed to include the .dpm or .bpm file extension. The files look like this:

```
-- Defective Pixel Map,
-- Date: 2.23.2018,
-- Model#: CXP-C6440M,
-- Serial#: LAC001,
:Table,
-- Column (X) , Row (Y)
    5683,155
    3091,332
    3532,893
    650,1017
    701,1017
    1712,1053
    914,1067
```

Pixel maps have two main sections: a header and a table. The header section is a free text area of up to 256 ASCII characters. Each line of the header section must be terminated with a comma. The table section of the file contains an array of lines with each line containing an X (column number) value followed by a comma and a Y (row number) value.

All pixels are listed in the DPM or HPM in order of increasing Y (row) location. If the Y location is identical, the listing is in order of increasing X (column) location.

The maximum number of pixels in the DMP list is 1024 and in HPM list is 4096.

To create a DPM or HPM file:

1. Identify defective or hot pixels (refer to the sections [Finding Defective Pixels](#) and [Finding Hot Pixels](#)).

IMPORTANT: When creating a new pixel map, you need to get all defective pixel visible. Make sure that the *DefectivePixelCorrection* and *BadPixelCorrection* are set to Off in the Data Correction menu of the software GUI, so the camera does not correct the known pixel defects.

2. Locate and adjust defective pixels' coordinates (refer to the section [Locating and adding pixel coordinates](#), **STEP1 – STEP3**).
3. Place pixels' coordinates into the pixel map and save the file (refer to the section [Locating and adding pixel coordinates](#) **STEP4, STEP5**).

EXAMPLE

In this example, the first table entry is pixel 4 from row 1, the next entry is pixel 588 from row 1, and the next entry is pixel 78 from row 5, and so on. The file looks like this:

```
:Table,
-- Column (X) , Row (Y)
    4,1
    588,1
    78,5
    82,27
    405,300
```

Creating a DPM Using Imperx Toolkit

1. Set *DefectPixelCorrection* to **Off** in the Data Correction menu.
2. Make sure that *BadPixelCorrection* is set to **Factory**.
3. Make sure that *TriggerMode* and *ExposureMode* are set to **Off**, and the camera resolution is set to maximum.
4. Capture an image (or series of images) with a uniform light source illuminating the sensor at about 50% ADU capacity (~2000 for 12-bit, ~500 for 10-bit, ~130 for 8-bit modes) and Save the image(s) in RAW format.
5. In the *lpxToolkit* main window, navigate to the saved RAW file(s) and open it.
6. On the **Image Properties** tab:
 - Set **Device Type** GigE Vision.
 - Set **Width** and **Height** to the RAW image's vertical and horizontal size respectively.
 - Set **Pixel Type** to the Pixel Format of the RAW image.
The options are Mono8, Mono10, or Mono12 for a monochrome camera and RGB8, RGB10, or RGB12 for a color camera.
 - Click **Apply**.
7. Select **Tools > DPM/HPM Utility**.
8. On the **Dark & Bright** tab, navigate to the saved RAW file(s) and open it.
9. Move the **Dark** slider to the value that you want to be the maximum luminosity for the dark pixels.
The pixels are treated as dark if their luminosity is lower than the Dark limit.
10. Move the **Bright** slider to the value that you want to be the minimum luminosity for the bright pixels.
The pixels are treated as bright if their luminosity is higher than the Bright limit.
11. Click **Start**.
The dark and bright pixels are added to the **List of Defected Pixels** table.
The maximum number of pixels in the DMP is 1024.
12. Fill out the **Camera** and **Serial#** fields and click **Save to File**.

Creating an HPM Using Imperx Toolkit

1. Set *BadPixelCorrection* to Off in the Data Correction menu.
2. Make sure that *DefectivePixelCorrection* is set to Factory.
3. Set the longest exposure time and slowest frame rate expected.
4. Cover a lens with a lens cap or dismount the lens and put on a dust cap on the.
5. Run the camera for at least 45 minutes at ambient temperature around 18–22 °C or higher.
6. Capture an image (or series of images) and save it in RAW format.
7. In the IpxToolkit main window, navigate to the saved RAW file(s) and open it.
8. On the **Image Properties** tab:
 - Set **Device Type** to GigE Vision.
 - Set **Width** and **Height** to the RAW image's vertical and horizontal size respectively.
 - Set Pixel Type to the Pixel Format of the RAW image.
The options are Mono8, Mono10, or Mono12 for a monochrome camera and RGB8, RGB10, or RGB12 for a color camera.
 - Click **Apply**.
9. Select **Tools > DPM/HPM Utility**.
10. On the **Hot** tab, navigate to the saved RAW file(s) and open it.
11. Move the **Threshold** slider to the value that you want to be the minimum luminosity for the hot pixels.
The pixels are treated as hot if their luminosity is higher than the Threshold limit.
12. Click **Start**.
The dark and bright pixels are added to the **List of Defected Pixels** table.
The maximum number of pixels in HPM is 4096.
13. Fill out the **Camera** and **Serial#** fields and click **Save to File**.

Uploading DPM / HPM Files

After saving the maps, you can upload them to the camera using the Imperx **Upload Utility**. The Upload Utility enables uploads of DPM, HPM, and other files to your camera.

To upload DPM and HPM files:

1. Connect and power up your camera.
2. Start the Imperx **Upload Utility** and wait for the Utility to detect the camera. If the utility does not detect the camera, click **Refresh** to restart the device collection.

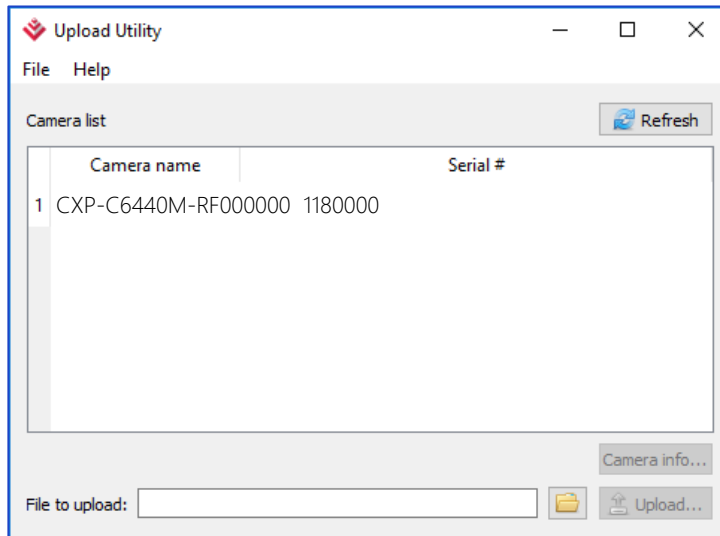

3. Select the camera to update if more than one appears.

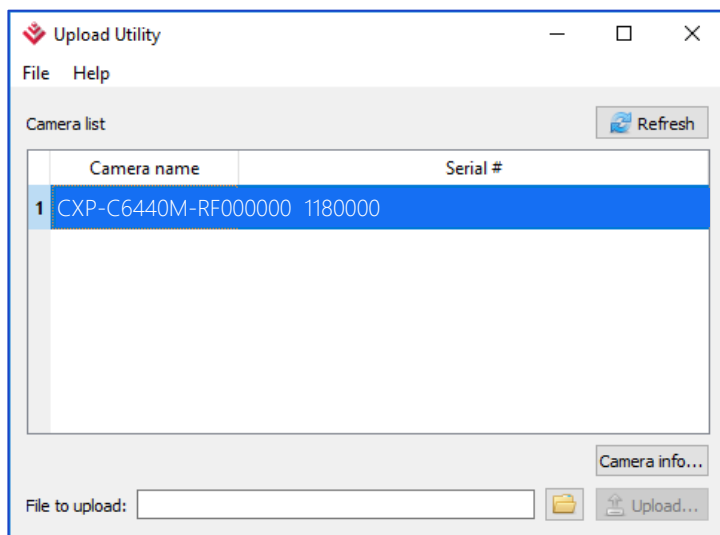

4. Browse for either the edited .dpm file or .hpm file, select it, and click **Upload**.
Wait for the upload to finish and click **Close**.

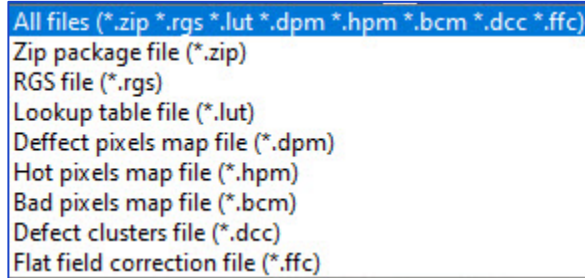

5. After the upload is completed, do a power cycle on the camera.
6. After the camera re-starts, start your software GUI and select **Data Correction**.
7. Make sure that *DefectivePixelCorrection* and *BadPixelCorrection* are set to **User** so that the camera uses the maps you loaded.
8. Retake images as described in sections [Finding Defective Pixels](#) and [Finding Hot Pixels](#) to make sure that all defective and hot pixels are now corrected.

Appendix C: Look Up Tables

Creating an LUT Using a Text Editor

You can use any ASCII text editor, such as Notepad or similar, to create a custom LUT. Alternatively, any spreadsheet program (i.e. Microsoft Excel) can be used by converting the spreadsheet into a comma delimited (.csv) file. In either case, rename the file to include the .lut file extension.

The .lut file has two main sections: a header and a table. The header section is a free text area of up to 256 ASCII characters. Each line of the header section must be terminated in a comma. The table section of the file contains an array of 4096 lines with each line containing an input value followed by a comma and an output value. The input values represent incoming pixels and the output values represent what each incoming pixel should be converted into as an output pixel.

The format of the .lut file is as follows:

```
-- Look Up Table input file example,  
-- lines beginning with two dashes are comments,  
-- and are ignored by parser,  
:Header,  
-- this is the text that will get displayed with a 'glh' command,  
Function is 'Negative Image',  
Created by John Doe,  
Date 1/14/20,  
:Table,  
-- input output,  
    0,4095  
    1,4094  
    2,4093  
    3,4092  
    4,4091  
    :  
4095,0
```

Creating an LUT Using Microsoft Excel

The LUT file can be created in Excel as follows:

1. Create the spreadsheet as shown below (note that 4096 rows are required in the table).
2. Add the necessary equations into the output cells to generate the transfer function required.
3. Save the file as a .csv (comma delimited format).
4. Rename the .csv file to an extension of .lut.

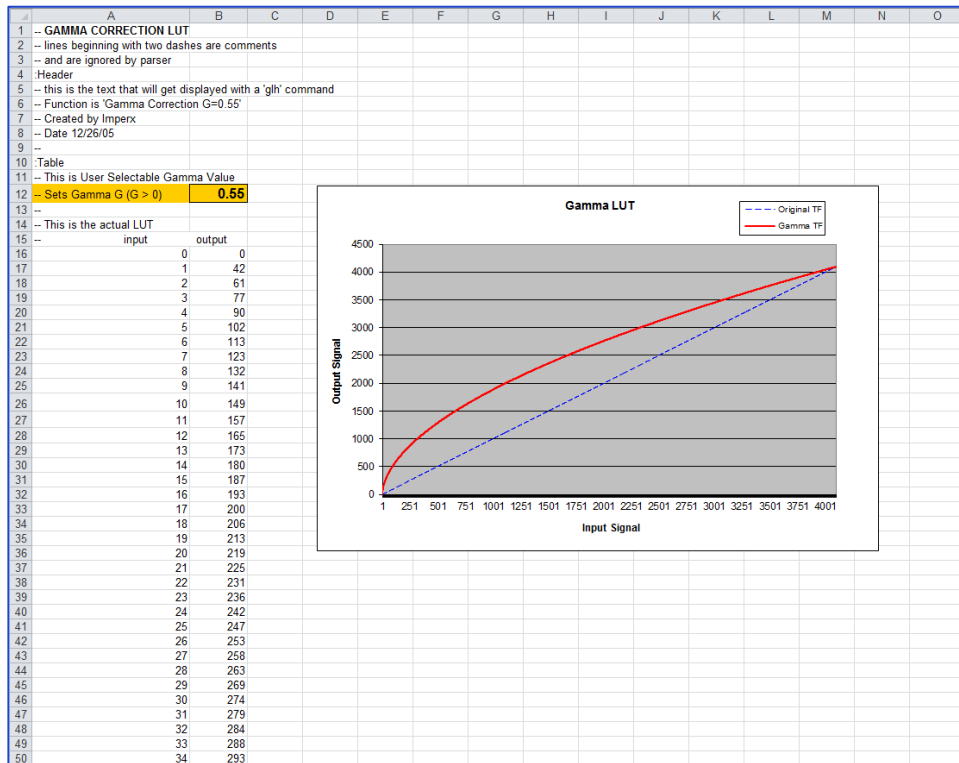

Creating an LUT Using Imperx Toolkit

1. On the Tools tab, open LUT Manager utility.
2. Create a new LUT file. On the Create LUT dialog box, select the LUT type, set the input and output bit depth to 12, and click **OK**.

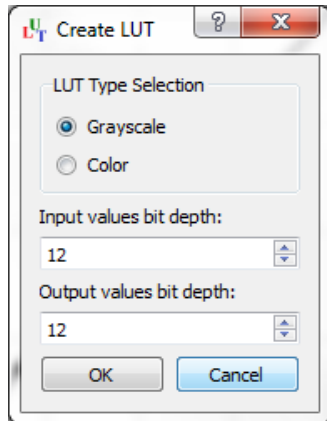

3. Click **Customize** under the LUT plot.
4. Click **More**, set **Curve type** to Dots and **Formula** to User.
5. Type in a formula for the new LUT.
The following operands and operations are available:

Operation	Description
+	Addition
-	Substraction
*	Multiplication
/	Division
^	Raise to the power of
cos	Cosine function
sin	Sine function
tan	Tangent function
acos	Arc-Cosine function
asin	Arc-Sine function
atan	Arc-Tangent function
sqrt	Square root
ln	Log natural
exp	Exponent

Operator	Description
x	x-value
pi	Mathematical constant approximately 3.1415926535897932

6. For a color camera, you can set a transfer function for each channel. Use R, G, and B tabs on the left to switch between the channels.
7. To save the LUT file, go to **File > Save as....**

Example

A modified sigmoid function can be used to enhance low contrast images. The modified sigmoid function is given below:

$$F(x) = \frac{1}{1 + e^{-a(x-b)}}$$

where **x** is the input pixel value.

a is a contrast factor. It determines the steepness of the curve (0.5 – low gain; 10 -high gain).

b is a threshold level. It determines a sigmoid’s midpoint. A midpoint is the brightness of input pixels that is used as a reference. If the brightness of an input pixel is higher than a midpoint, the output pixel value is increased. Otherwise, the output pixel value is decreased.

In the LUT Manager window, type in the following formula under the *Formula* control (with a=4 and b=2):

$$4095*(1/(1+(exp(-4*(x/(4095/4)-2))))))$$

The function is scaled so that the input and output pixel values are within the range from 0 to 4095 (for a 12-bit image).

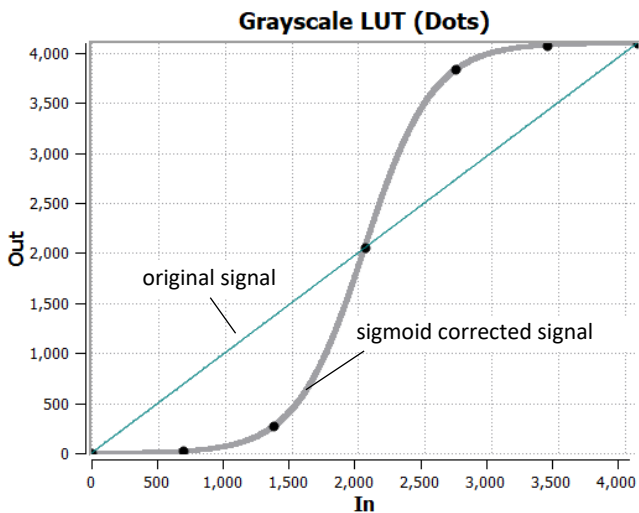

To adjust the overall brightness and contrast of the image, use both threshold and contrast factor parameters. The threshold value controls the amount of brightness, and the contrast factor controls the difference between pixels.

The sigmoid curves with varied threshold and contrast factor parameters are shown below:

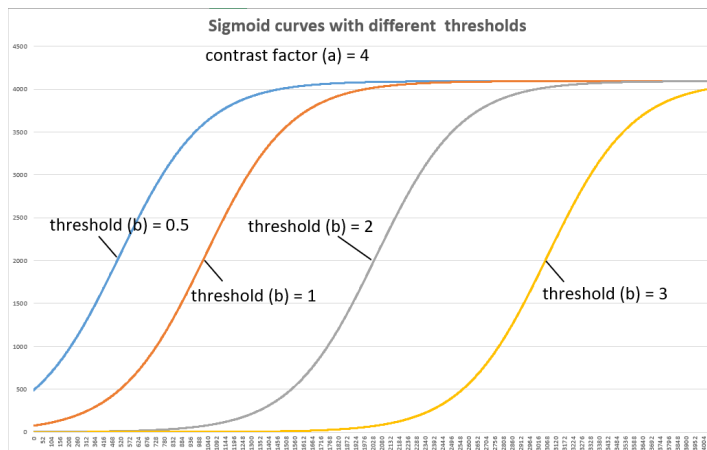
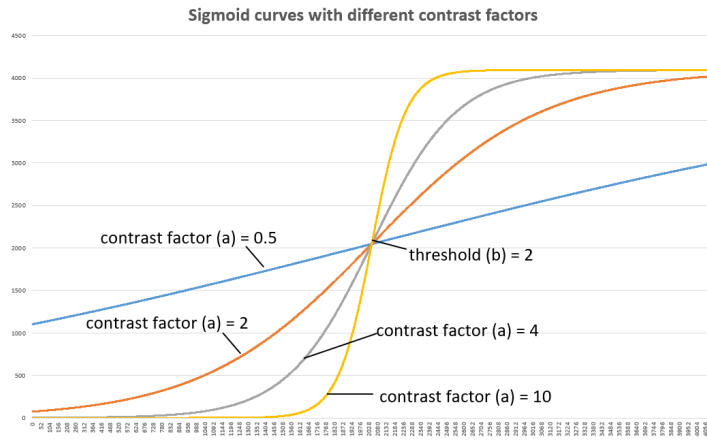

To apply a convex part of the curve within the range from 0 to 4095, use the following formula:

$$2 * 4095 * (1 / (1 + (\exp(-2 * (x / (4095 / 4)))))) - 0.5$$

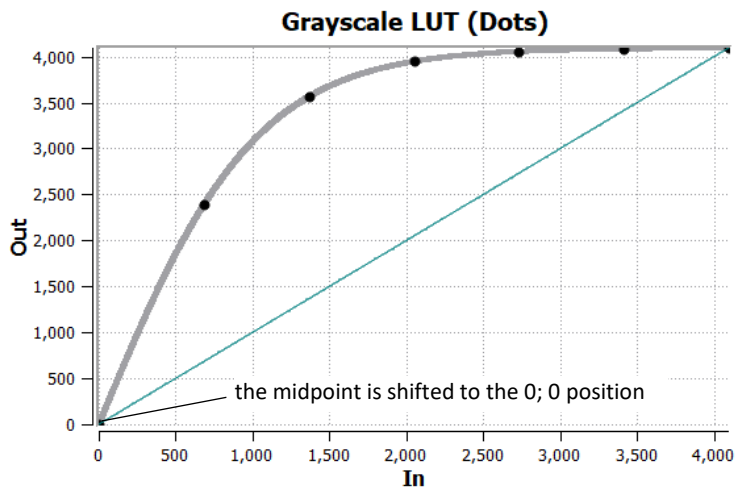

To apply a concave part of the curve within the range from 0 to 4095, use the following formula:

$$2*4095*(1/(1+(\exp(-2*(x/(4095/4)-4))))))$$

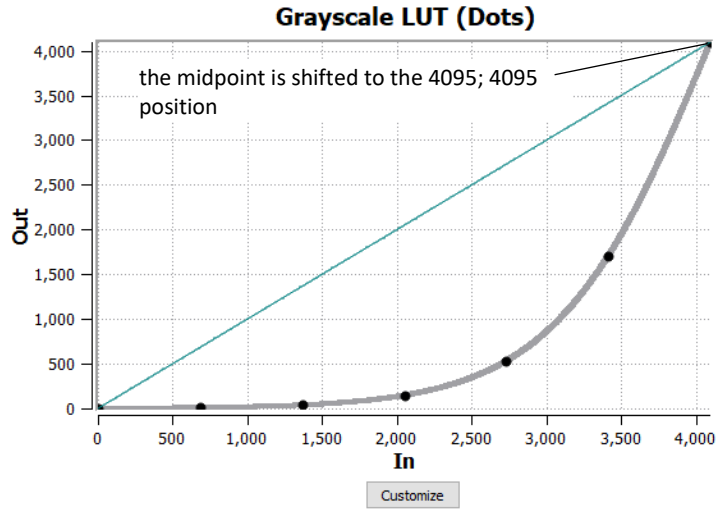

Uploading the LUT File

After saving the LUT into the .lut file, you can upload it into the camera using the Imperx **Upload Utility**.

To upload the LUT file:

1. Connect and power up your camera.
2. Start the Imperx **Upload Utility** and wait for the Utility to detect the camera. If the utility does not detect the camera, click **Refresh** to restart the device collection.

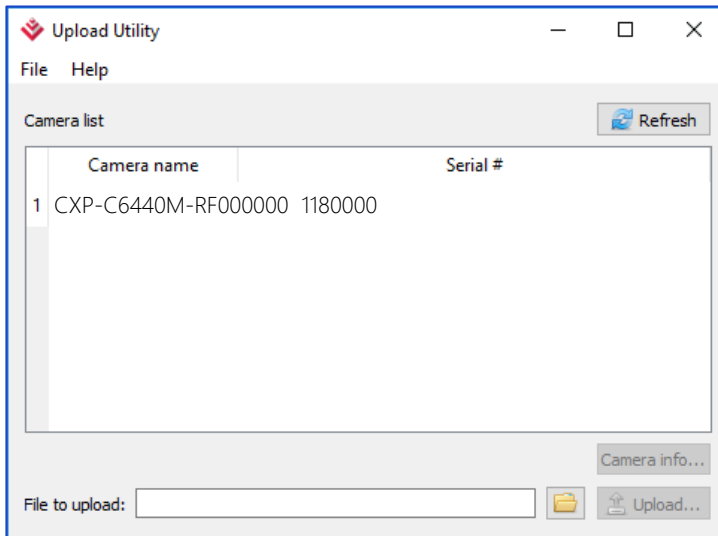

3. Select the camera to update if more than one appears.

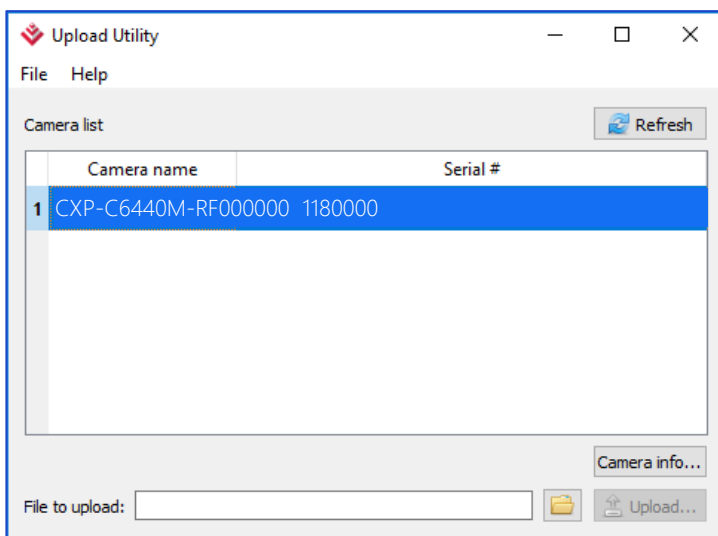

4. Browse for the .lut file, select it, and click **Upload**.
Select to which camera's LUT (LUT1–LUT4) to upload the .lut file you created.
Wait for the upload to finish and click **Close**.

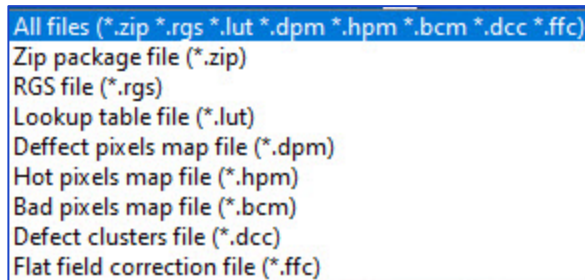

5. After the upload is completed, do power cycle the camera.
6. After the camera re-starts, start the software GUI and select **Data Correction**.
7. Set *LUTEnable* to the LUT you uploaded.
The camera then uses the LUT you uploaded.